

DATI TECNICI / TECHNICAL DATA / TECHNISCHE DATEN
 CARACTÉRISTIQUES TECHNIQUES / DATOS TÉCNICOS / CARACTERÍSTICAS TÉCNICAS

CV RCV	i	n ₁ = 2800 min ⁻¹			n ₁ = 1400 min ⁻¹			n ₁ = 900 min ⁻¹					
		n ₂ min ⁻¹	Mn ₂ Nm	P ₁ kW	n ₂ min ⁻¹	Mn ₂ Nm	P ₁ kW	n ₂ min ⁻¹	Mn ₂ Nm	P ₁ kW	IEC B5	IEC B14	NEMA
162	3.70	757	31	2.6	378	37	1.5	243	41	1.1	56-63-71-80	56-63-71-80	56
	5.10	549	34	2.0	275	41	1.2	176	46	0.89	56-63-71-80	56-63-71-80	56
	7.11	394	40	1.7	197	48	1.0	127	54	0.75	56-63-71-80	56-63-71-80	56
	7.62	367	39	1.6	184	47	0.94	118	52	0.67	56-63-71-80	56-63-71-80	56
	9.80	286	45	1.4	143	54	0.84	92	59	0.59	56-63-71-80	56-63-71-80	56
	11.95	234	50	1.3	117	60	0.77	75	66	0.54	56-63-71-80	56-63-71-80	56
	14.63	191	51	1.1	96	62	0.65	62	68	0.46	56-63-71-80	56-63-71-80	56
	16.47	170	53	0.98	85	64	0.59	55	71	0.42	56-63-71-80	56-63-71-80	56
	20.74	135	54	0.80	68	66	0.49	43.4	73	0.35	56-63-71-80	56-63-71-80	56
	24.59	114	57	0.71	57	69	0.43	36.6	77	0.31	56-63-71-80	56-63-71-80	56
	25.51	110	55	0.66	55	66	0.40	35.3	72	0.28	56-63-71-80	56-63-71-80	56
	28.57	98	56	0.60	49.0	67	0.36	31.5	75	0.26	56-63-71-80	56-63-71-80	56
	35.14	80	55	0.48	39.8	66	0.29	25.6	67	0.19	56-63-71-80	56-63-71-80	56
	42.67	66	58	0.42	32.8	69	0.25	21.1	69	0.16	56-63-71-80	56-63-71-80	56
	52.48	53	68	0.40	26.7	71	0.21	17.2	74	0.14	56-63-71-80	56-63-71-80	56

DIMENSIONI / DIMENSIONS / ABMESSUNGEN / DIMENSIONS / DIMENSIONES / DIMENSÕES

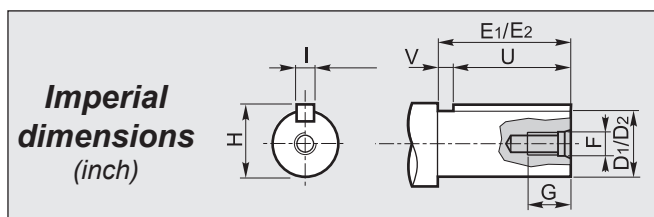
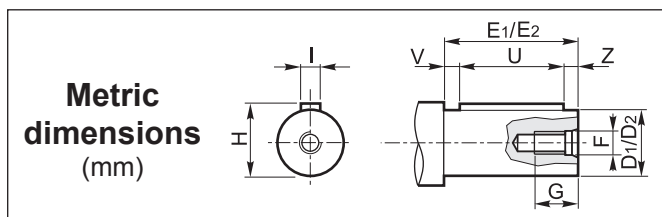

1 **Albero entrata / Input shaft / Antriebswelle**
 Arbre d'entrée / Eje de entrada / Eixo de entrada

D ₁ h6	E ₁	F	G	H	I	U	V	Z
16	40	M6	15	18	5	25	10	5

1 **Albero entrata / Input shaft / Antriebswelle**
 Arbre d'entrée / Eje de entrada / Eixo de entrada

D ₁	E ₁	F	G	H	I	U	V
0.625	1.575	1/4-20	0.630	0.704	0.187	1.000	0.575

2 **Albero uscita / Output shaft / Abtriebswelle**
 Arbre de sortie / Eje de salida / Eixo de saída

D ₂ h6	E ₂	F	G	H	I	U	V	Z
11	23	M4	10	12.5	4	16	3.5	3.5
14	30	M5	12	16	5	20	5	5
16	40	M6	16	18	5	30	5	5
19	40	M6	16	21.5	6	30	5	5
20	40	M8	19	22.5	6	30	5	5

2 **Albero uscita / Output shaft / Abtriebswelle**
 Arbre de sortie / Eje de salida / Eixo de saída

D ₂	E ₂	F	G	H	I	U	V
0.625	1.575	1/4-20	0.630	0.704	0.187	1.000	0.575

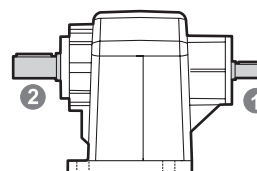

A richiesta / On request / Auf Anfrage / Sur demande / Bajo demanda / Sob consulta

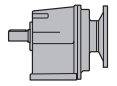

DIMENSIONI / DIMENSIONS / ABMESSUNGEN / DIMENSIONS / DIMENSIONES / DIMENSÕES

P

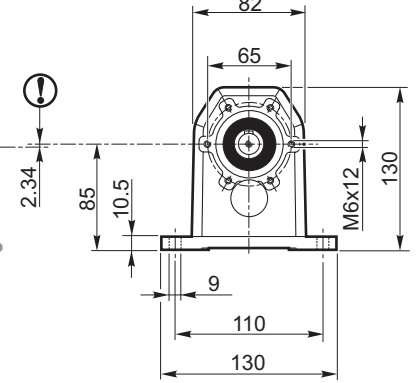
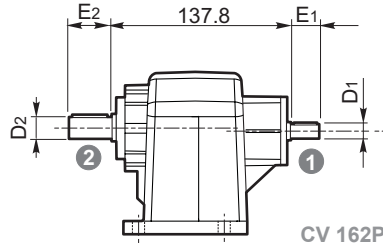
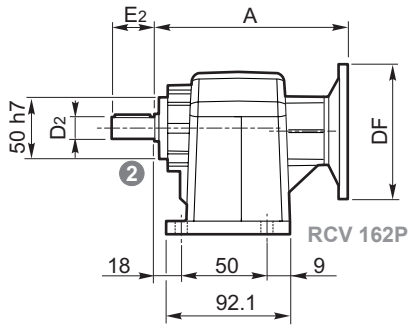

N

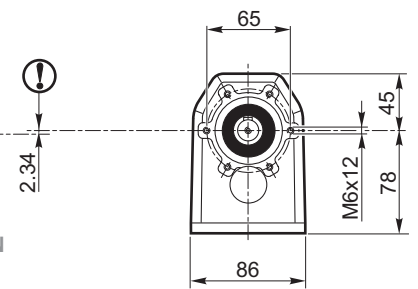
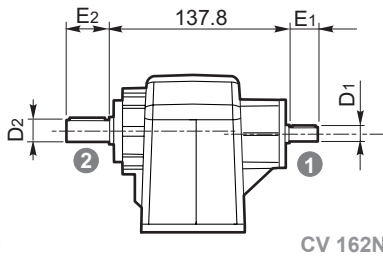
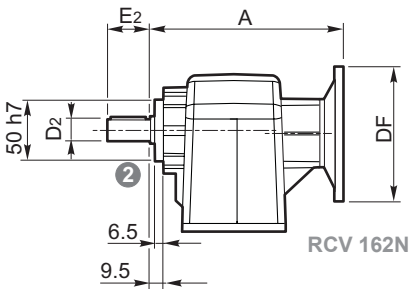

NF

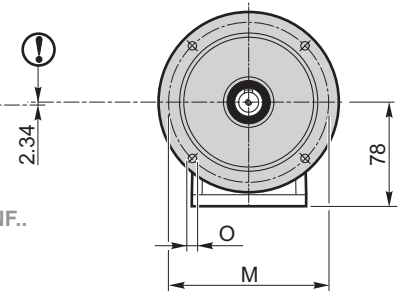
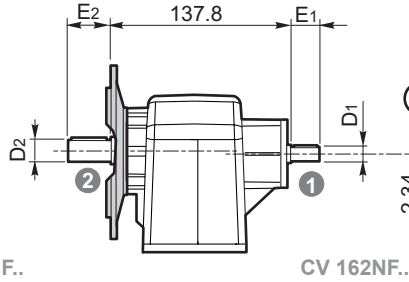
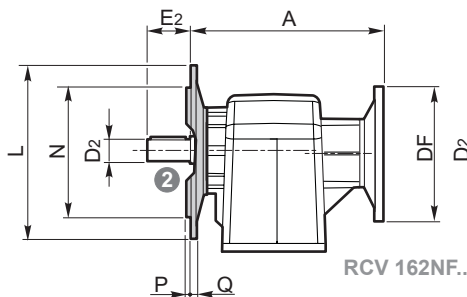

PF

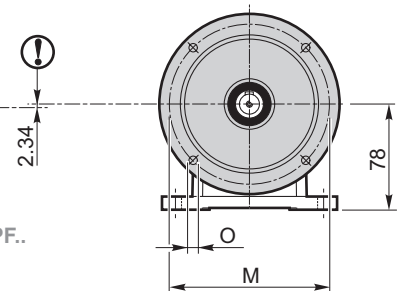
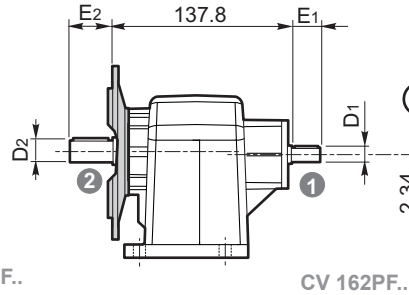
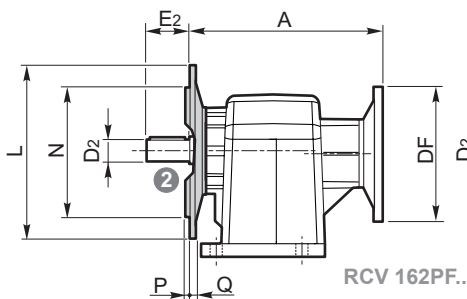

RCV CV	RCV						
	IEC	DF		A	NEMA	DF	A
		(B5)	(B14)				
162	56	120	80	141	56	165.1	160
	63	140	90				
	71	160	105				
	80	200	120				

	L	M	N h8	O	P	Q
NF120 - PF120	120	100	80	9	3	9
NF140 - PF140	140	115	95	9.5	3	9
NF160 - PF160	160	130	110	9.5	3.5	9