

/2W

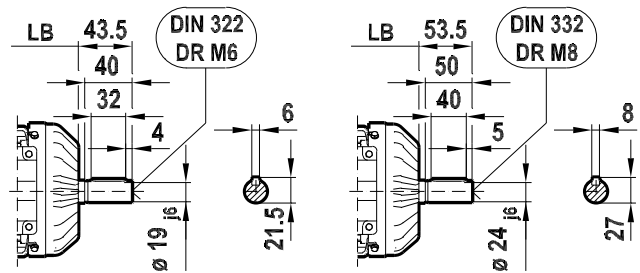

DRS112M 2; 4; 6; 8/2; 8/4

DRE112M 2; 4; 6

DRP112M 2; 4; 6

/FF (B5) FF215

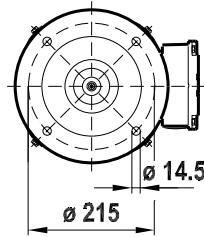

/Fl.. (B3)

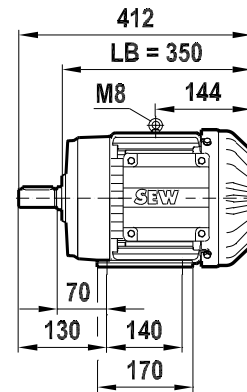
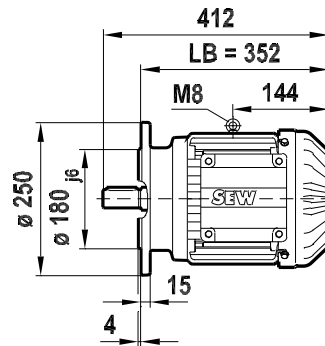
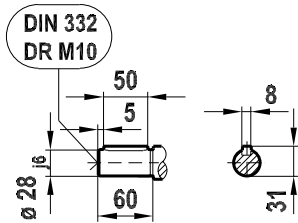
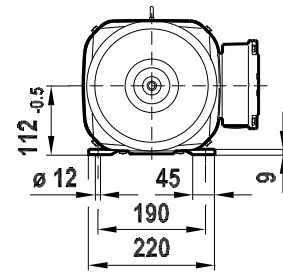

DR.112M

08 276 04 07

2 (2)

/IV

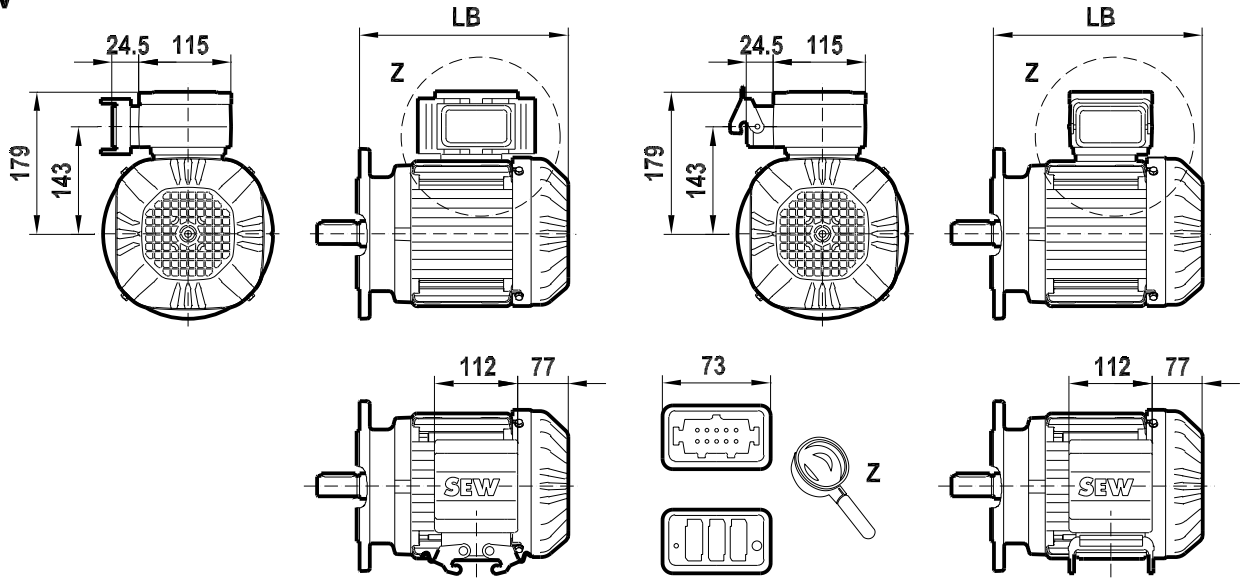

/IS

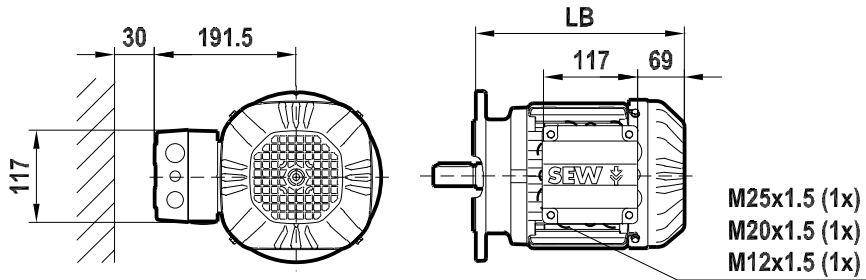

/IC

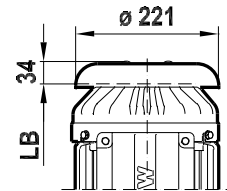

/ES7.

/ES7A

/AS7.

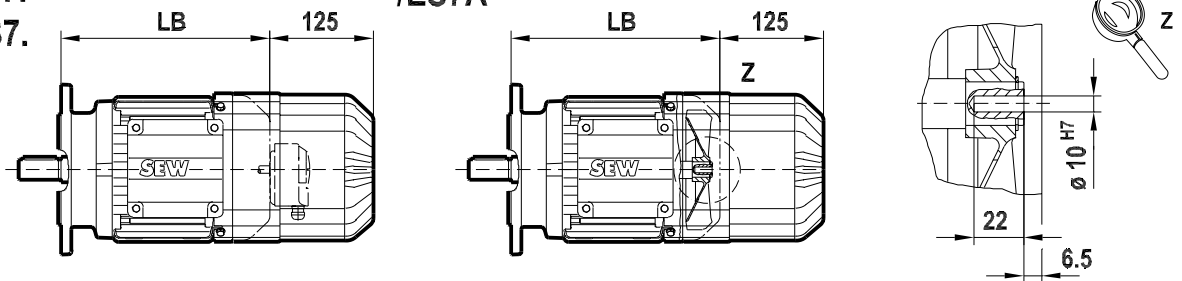

/ES7.IV

/IV

/AS7.IV

