

Zip
+7(812) 642-58-00
sale@planetazip.ru



**PRODUCTION PROGRAMME
DRIVE AND TRANSPORT
APPLICATIONS 2008**



Endless
homo-
geneous,
constant
weight,
reliable...

Endless
precise,
perforated,
customi-
zed ...

Endless
high running
accuracy,
low vibration,
flexible...

Endless
tear-
resistant,
elastic,
customi-
zed ...

Endless
BGA/FDA-
approved,
easy to clean
temperature-
resistant...

Endless
reliable in
temperature
ranges up
to 300°C ...

Endless
robust,
reliable,
durable ...

Endless
diverse,
unique,
solution-
orientated ...

Endless
abrasion-
resistant,
ozone-
resistant,
customi-
zed ...

Endless
functionally
strong,
innovative,
specific ...

Weighing belts

Vacuum conveyor belts

Drive belts

Conveyor belts

Food transport

Temperature-resistant belts

Machine and process belts

Special belts (to customers' specifications)

Conveyor belts for paper transport and paper handling

Coating materials for timing belts and Multi-V belts





Performance

For over 50 years Max Schlatterer GmbH & Co. KG have been developing and manufacturing endless belts – drive belts, conveyor belts, belts made to customers' requirements – in two factories in southern Germany. We actively contribute in the entire world to the development of innovative production plants, supply convincing band and belt designs, we realize these ideas on equipment developed by our own specialized personnel and supply 100% quality by using electronic testing equipment. We are partners to significant companies in many different industries. And in the cigarette industry we are thus far ahead of our competitors.

Advantage

Schlatterer supply endless belts in all sizes up to a length of 4,800 mm and a width of 600 mm. Special sizes are available upon request. Due to our specific production techniques and production equipment, Esband products are unique. Intensive research and development in close co-operation with the machine manufacturers constantly produce new, innovative bands and belts. They provide our customers with a competitive edge and offer a high degree of security for their production processes, based on superior characteristics over the entire belt length.

Philosophy

Where demands are high, the Endless Schlatterer Belt (Esband) convinces. They are manufactured according to our truly endless method without a single seam or splice. Thus, Esband is absolutely reliable and durable even at high speeds and in complicated environments.

Many of our Esband drive belts, conveyor belts and special belts have been patented. A wide variety of basic materials and surface treatments guarantee the perfect belt for every application. A comprehensive marketing and service network in over 80 countries world-wide ensures a close co-operation with our customers.

About us

Development

A good fifty years ago, the vision of frictionless production processes inspire the belt maker Max Schlatterer with an ingenious idea: He manufactures a ring-shaped, woven, endless drive and conveyor belt without beginning or end and without any joints. Its advantages in terms of performance, flexibility and durability prove to be enormous.

Schlatterer recognizes the far-reaching significance of his invention, registers the patent, generates lively interest and achieves his first successes.

High-performance materials constantly lead to further refinements. Fame and commercial importance grow. Small at the outset, the enterprise develops rapidly. In the 1960s Schlatterer employs 140 people in the Swabian town of Herbrechtlingen. By the 1980s this figure has increased to more than 300. And already at an early stage, he begins to invest in environmentally friendly methods of production.

Today over 600 highly motivated employees in two closely located production sites covering a total area of 20,000 m² strive for further growth. A superior product range, great enthusiasm for innovation and highest, electronically controlled product quality have made Schlatterer GmbH & Co. KG one of the most efficient and significant belt manufactures throughout the world.

Overview of Contents	Page
Introduction:	
- Product overview	
- About us	
- Company development	3
Information section:	
- Endless / Drive / Transport	5
- Carcass materials / Coatings	7
- Coefficients of friction / Special process	9
Table section:	
- Foamed Polyurethane (PU)	11
- Neoprene Rubber	13
- FX, SI, PC	15
Technical data:	
- For designers	17
- Calculations	
Quality assurance	
- Tests	19
- Testing standards	
Fax enquiries:	
- For Drive belts	
- For Conveyor belts	

Endless

Endless advantages

The Esband brand name is applied exclusively to flat belts and conveyor belts made utilizing a genuinely endless technique. Made with no joints or splices, they offer countless advantages:

endless homogenisation

Esband offers uniform elongation values, tear resistances and thickness tolerances over the complete length – weak points are eliminated.

endless flexibility

Esband functions even over the smallest bending radii, frequent bending changes and over knife edges with absolute reliability.

endless quiet running

Esband totally avoids noise pulses that would otherwise be generated by joints and runs absolutely quietly.

endless care

Esband is bipolar: Low longitudinal elongation and transverse adaptability endow it with small initial tensioning forces and low shaft loads.

endless precision adaptability

Esband provides for individually matched carcass materials and coatings for economically viable production processes.

Schlatterer customers profit from intensive consultation, precise belt calculation and individual support.



Esband belts produced according to the truly endless method make your production process run smoothly: Precise tracking, low-vibration, low noise levels, durable – even at high rotary speeds and bending frequencies.

1. Open Belt Drives

- Flexible power transmission with low shaft loads and reduced wear
- Transmittable power of up to 60 kW (special purpose belts up to 150 kW)
- Temperature resistant up to 130°C
- Absorption of shock and vibration
- Suitable as overload protection
- High reliability

2. 90° Turn Belt Drives

- Easy design possibilities with non-parallel rotary axes

3. Cross Belt Drives / Half-Cross Belt Drives

- Easy design possibilities with changes in the direction of rotation

4. Multi-Shaft Drives

- Torque reduction drives with long service life at high bending frequencies

5. Spindle Drives

- Spindle conveyors and tangential belts used in the textile industry
- Suitable for smallest bending radii and high belt speeds

Light-Duty Drives – up to approx. 2.5 kW

Extremely wear resistant belts with superior running and traction properties, high flexibility, precisely coordinated coefficients of friction, antistatic. Typical applications:

- High-speed drives
- Office equipment
- Household appliances and do-it-yourself equipment
- Grinders
- Saws
- Testing equipment
- Spindle drives
- Spinning frames
- Bobbin machines
- Textile machinery

Medium-Duty Drives – up to approx. 15 kW

Extremely wear resistant belts with superior running and traction properties, low noise operation, low

elongation, antistatic. Typical applications:

- High-speed drives
- Woodworking machinery
- Floor maintenance equipment
- Do-it-yourself equipment
- Grinders
- Machine tools
- Textile machinery
- Construction equipment
- Low humidity atmospheres

Heavy-Duty drives – up to approx. 60 kW

Extremely wear resistant belts with good traction properties, running neutrality, limited elongation. Typical applications:

- Especially for balancing machines
- Construction machinery
- Eccentric presses
- Woodworking machinery
- Ventilation fan drives
- Grinding gear
- Motor testing rigs
- Turbine drives
- Hydro-electric stations
- Mills
- Testing equipment

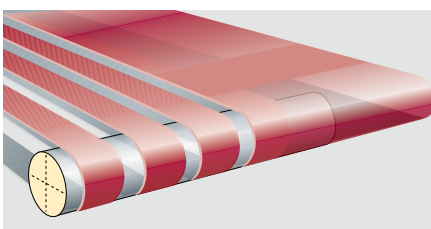
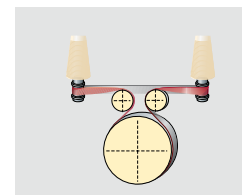
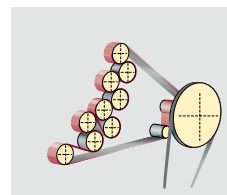
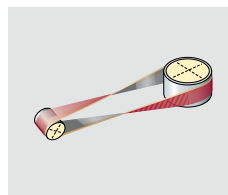
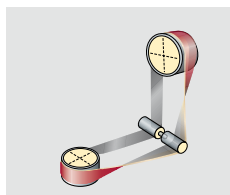
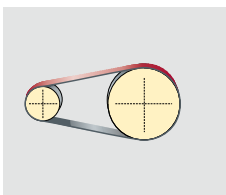

Esband conveyor belts produced according to the truly endless method enable frictionless processes. Each category of goods transported requires a specific type of band; each environment makes its specific demands. The following list includes the most important fields of application:

Paper

For paper processing and paper handling Esband offers bands with various degrees of elasticity, high ozone-resistance, high breaking strength or low elongation, based on your requirements. Typical applications: Printing machines, copiers and scanners, cash dispensing and ticket issuing

machines, paper and cardboard processing machines.

Food Transport

Esband enables delicate processing and packaging of food. Our belts are FDA/BGA approved, easy to clean, temperature resistant with varying degrees of elasticity and flexibility and various coefficients of friction. Typical applications: knife edges, transfer stations, automatic packaging machines, cheese-making machines, bakery lines.

Weighing Technology

Esband brings weighing technology to peak perfection as our belts are truly homogeneous over their entire length (including weight), with exactly adapted coating and elongation characteristics, special surface finishes and low-friction covers on the running side. Typical applications: For light-weight bulk materials and unit goods, dynamic weighing devices, knife edges, small bending radii.

Transport

Bulk Material and Unit Goods

Esband transports every kind of unit goods and bulk material of all weight categories to perfection as our belts have exactly matched coefficients of friction, ideal elongation characteristics, self-tracking guides, perforations for vacuum transport, etc. Typical applications: Fixed shaft centre distances, knife edges, slider beds, vacuum transport.

Special Conveyor Belts

Esband supplies conveyor belts with special surface treatments for conveying of unit goods and bulk materials under extreme conditions. Typical applications: Sharp ascent angles, highest temperatures, inclined feeder conveyors, synchronous and/or vacuum transport.

Carcass Materials

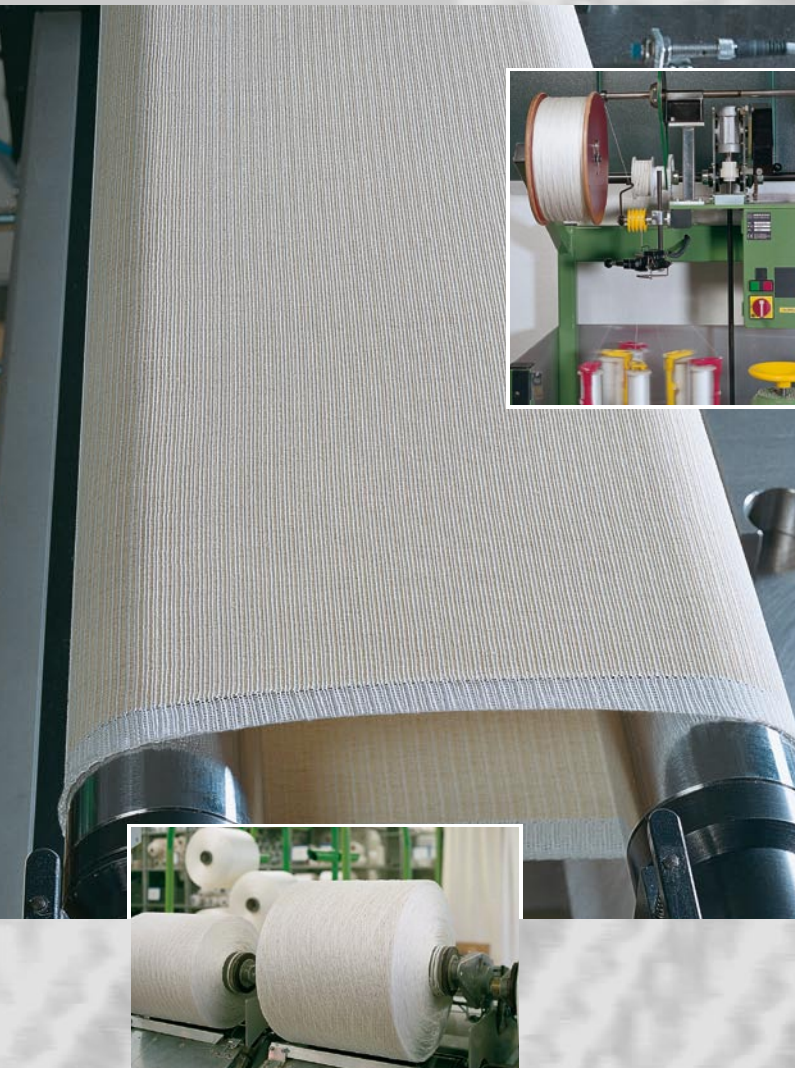

We produce our Schlatterer special fabric in endless form on modern knitting machines. It is the base of each treatment, coating and refinement process.

Depending upon the carcass material, belts with specific properties are produced.

1. Schlatterer Special Fabric

is manufactured in endless form on the most modern knitting machines.

Elastic yarn

- High elastic elongation from 4 – 10%
- For fixed shaft centre distances
- No tensioning device necessary

Polyamide

- Medium elastic elongation from 0.5 – 1.5%
- For fixed shaft centre distances

Polyester

- Low elastic elongation
- Resistant to chemicals

Cotton yarn

- Low elongation
- Low coefficient of friction

Aramide

- Extremely low elongation
- Low coefficient of friction
- Temperature-resistant up to 280°C

Nomex

- Low elongation
- Temperature-resistant up to 300°C

Glass fibre

- Low elongation
- Low coefficient of friction
- Temperature-resistant up to 300°C

2. Timing belts, Multi-V belts

provided by our customers are coated with Polyurethane or Neoprene on the back, without joints or splices.

The resistance of the carcass fabric to chemical influences varies as follows:

Aggressive medium	Carcass				
	Polyester	Cotton	Aramide	Nomex	Glass fibre
Water	+	+	+	+	+
Oils, grease	+	○	+	+	+
Diluted acids	+	+	+	+	+
Diluted bases	+	+	+	+	+
Aromatics	+	+	+	+	+
Alcohol	+	+	+	+	+
Aliphatic compounds	+	+	+	+	+
Chlorinated hydrocarb.	+	+	+	+	+
Ketones	+	+	+	+	+
Dimensional stability					
at high humidity	+	-	+	+	+
With highly fluctuating temperatures	+	+	+	+	+

High = +
 Medium = ○
 Low = -

All Esband coatings are applied as an endless cover; you can thus specify the running direction of the belt yourself. We coat flat belts, timing belts and Multi-V belts. You can also order small batches at reasonable prices in the sizes you require.

According to your application, we recommend the following coating material:

Polyurethane

- Foamed (yellow, grey, white, red)
- Compact (white, FDA)
- Temperature-resistant up to 60°C (short-term up to 80°C)
- Good coefficient of friction to paper
- Different hardness versions available
- Thickness up to max. 10 mm

Natural Rubber

- Red (hardness approx. 42° ShA)
- Maroon (hardness approx. 50° ShA)
- Extremely high coefficient of friction
- Temperature-resistant up to 70°C
- High elasticity
- High resistance to tear propagation

Neoprene Rubber

- Black
- Hardness approx. 75°ShA
- High resistance to abrasion
- High coefficient of friction
- Good wear resistance to oils, grease, ozone
- Temperature-resistant up to 100°C
- very flexible
- Electrically conductive

NBR Rubber

- Light grey, blue, white
- High resistance to abrasion
- High coefficient of friction
- Very good resistance to

oils and grease

- Temperature-resistant up to 100°C
- BGA/FDA-approved (white)

xNBR Rubber

- Off-white
- Hardness approx. 75°ShA
- Extremely high resistance to abrasion
- Good coefficient of friction
- Good resistance to ozone
- extremely good resistance to oils and grease
- Temperature-resistant up to 130°C

Silicones

- White, grey
- Hardness approx. 30 – 35° ShA
- Thickness up to 10 mm possible
- Temperature-resistant up to 280°C
- High coefficient of friction
- Stain-resistant
- BGA/FDA approved
- Easy to clean when contaminated with adhesives

PVC

- Red
- Temperature-resistant up to 60°C
- Good resistance to chemical

EPDM

- Green
- Hardness approx. 65°ShA
- Very durable in extreme climates
- Temperature-resistant up to 80°C
- High coefficient of friction



The resistance to chemical influences is as follows:

Aggressive medium	Coating						
	Neoprene (NE)	Polyurethane (PU)	Silicone (SI)	Natural Rubber (NR)	NBR/xNBR	EPDM-Rubber	PVC
Water	+	○	+	+	+	+	+
Oils, greases	○	+	○	-	+	-	○
Diluted acids	+	-	○	+	+	+	+
Diluted bases	+	-	○	+	○	+	+
Aromatics	-	○	-	-	○	-	-
Alcohol	+	○	+	+	+	+	○
Aliphatic compounds	+	+	○	-	+	-	+
Chlorinated hydrocarbon	○	○	-	-	○	-	-
Ketones	+	-	-	-	○	+	-

High = +
 Medium = ○
 Low = -

Coefficient of Friction

The combination of different coating materials and surface designs on the running side and outside of the belt allow different solutions tailored to the specific application with special physical and chemical properties. And we offer nearly every combination of different coating materials.

Coefficients of friction in cleaned, brand new condition

Measured in compliance with German standard MSN 93 602 on ground or smooth surfaces. All figures are in $\mu \pm 0.1 \mu$

Esband Coating / Surface	Steel	Aluminium		Cast iron (GG25)	high-grade Steel	slider bed S-Green	PETP white	Paper	PE foil
		pure	anodised						
NE profiled	0,6	0,4	0,6	0,5	0,6	0,3	0,6	0,8	0,2
NE ground	0,5	0,5	0,6	0,7	0,5	0,3	0,7	0,8	0,3
NE smooth	0,6	0,6	0,8	>0,9	0,6	0,4	0,8	0,9	0,9
PU ground	0,4	0,4	0,8	0,4	0,3	0,2	0,6	0,8	0,2
PU foamy, ground	0,4	0,4	0,9	0,5	0,3	0,2	0,5	0,8	0,2
PU non-porous	0,3	0,5	0,6	0,8	0,3	0,2	0,4	0,5	0,2
PU low-friction coating	0,2	0,3	0,7	0,4	0,2	0,2	0,4	0,6	0,2
SI ground	0,4	0,4	0,6	0,5	0,3	0,2	0,3	0,6	0,3
SI sealed surface	0,7	0,8	0,9	0,8	0,5	0,4	0,8	0,9	>0,9
PVC profiled	0,7	0,8	>0,9	0,9	0,6	0,4	0,8	0,9	0,5
PVC smooth	0,6	0,8	0,9	0,8	0,5	0,4	0,8	0,9	>0,9
FX ground	0,4	0,3	0,4	0,5	0,2	0,2	0,4	0,7	0,1
FX smooth	0,5	0,4	0,5	0,6	0,4	0,1	0,2	0,4	0,9
FX T-profile	0,3	0,4	0,5	0,5	0,2	0,1	0,4	0,6	0,1
NK red or maroon, ground	0,8	0,8	0,6	0,9	0,6	0,7	0,6	0,8	0,7
NBR smooth, profiled, ground	0,4	0,4	0,4	0,5	0,3	0,3	0,4	0,5	0,8
NBR blue, profiled, ground	0,4	0,4	0,9	0,5	0,4	0,2	0,6	0,8	0,2
xNBR off-white, profiled, ground	0,3	0,4	0,5	0,4	0,3	0,2	0,5	0,6	0,2
EPDM smooth	0,8	>0,9	>0,9	0,9	>0,9	>0,9	>0,9	0,9	>0,9
EPDM ground, 80-grain	0,9	>0,9	>0,9	0,9	0,9	>0,9	>0,9	0,9	0,3
EPDM ground, 150-grain	0,9	>0,9	>0,9	0,9	0,9	>0,9	>0,9	0,9	0,4
Carcass PES raw, aramide, glass	0,2	0,2	0,3	0,2	0,2	0,1	0,2	0,3	0,1
Carcass cotton raw	0,1	0,2	0,3	0,2	0,1	0,1	0,2	0,3	0,1
Carcass NE impregnated	0,2	0,2	0,3	0,2	0,2	0,1	0,2	0,4	0,2

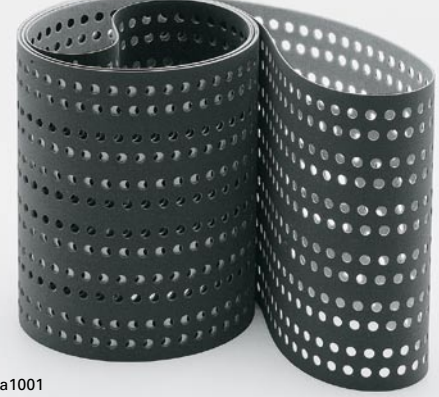

a1001



a1002



a1003



a1004



a1005

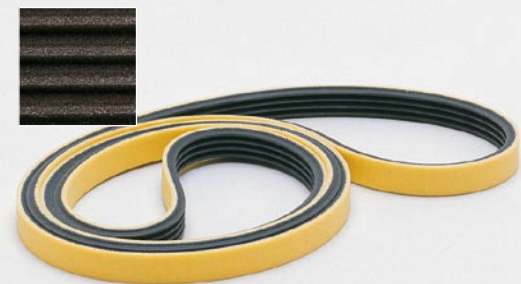

a1006



a1007



a1008



a1009



a1010



a1011



a1012



a1013



a1014



a1015



a1016



a1017



a1018



a1019



a1020



a1021



a1022



a1022



a1023



a1024



a1025



a1026

Special processing

An Esband is always a belt made exactly to your requirements in endless form.

For further processing we employ a computer-controlled five-axis machine. This in-house development permits perforations and recesses in almost any shape (e.g., for suction slots or transporting bags).

Following just a few examples out of a programme of endless possibilities:

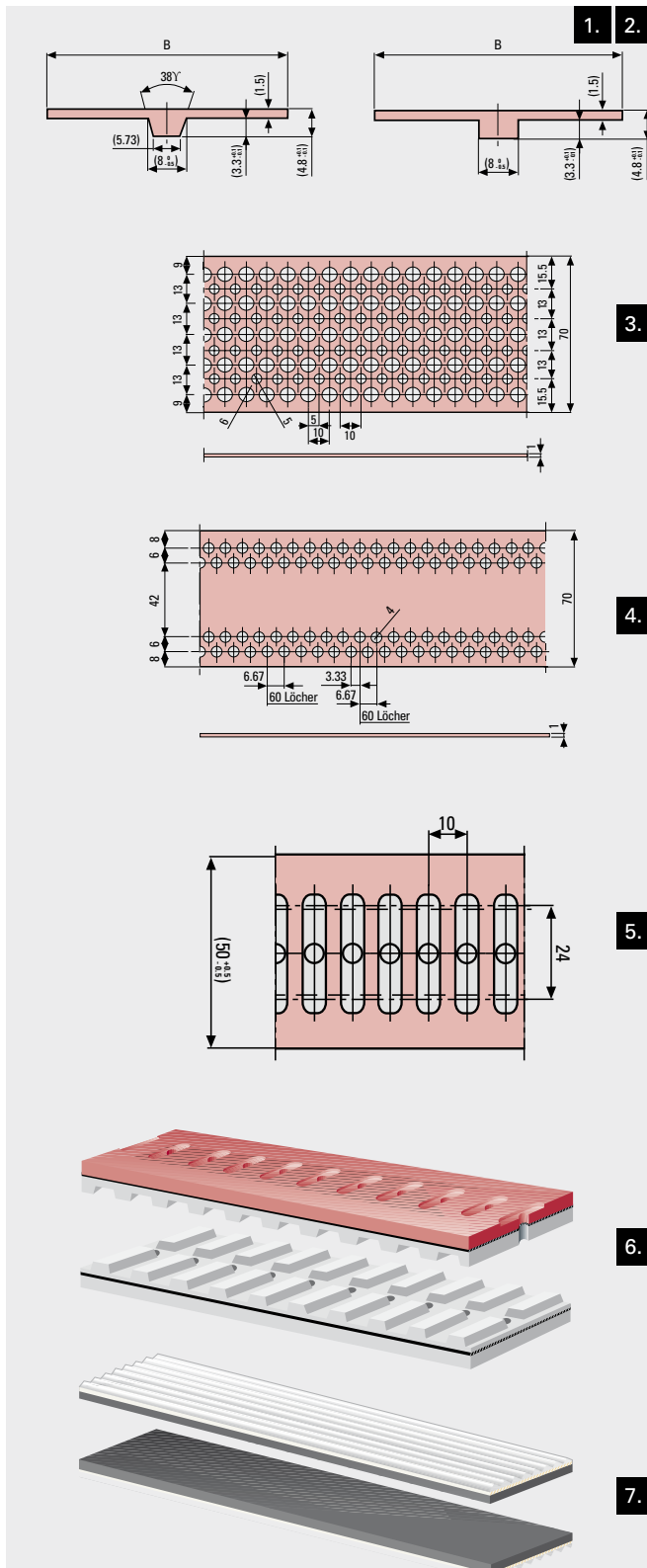

Fig. 1

Flat belts with self-tracking guides as guide wedges glued onto the running side or milled out of solid material.

Fig. 2

Flat belts with self-tracking guides as guide flanges glued onto the running side or milled out of solid material.

Fig. 3 + 4

Flat belts perforated with standard 1.5 - 10.0 mm diameter holes. Perforation pattern to customers' requirements. Special diameters on request.

Fig. 5

Flat belts with extra-thick coating on conveying side and incorporated suction slots and suction holes for vacuum transport with increased suction surface area.

Fig. 6

NE and PU timing belts with coating on the back and incorporated suction slots and suction holes as well as a suction channel milled into the tooth side of the belt, e.g., suction belt for packing machines for bags.

Fig. 7

Multi-V belt with coating on the back.



Esband type	Surface options	Tensile element	Coating/ Hardness *	Colours	Breaking strength per cm endless	Belt elongation [%] per cm endless at tensile force (axle load)		
						10 N	20 N	30 N
PU 0/6	- ground	without carcass	Polyurethane 55 ±7 ShA	yellow, grey white, red	140 N	10 N 8.5 – 9.5%	20 N 33 – 35%	30 N 72 – 76%
PU elastic	- coated on one side - coated on both sides - ground - non-porous ply - low-friction coating	Rubber cords/ Cotton	Polyurethane 55 ±7 ShA	yellow, grey white, red	250 N	10 N 1.8 – 3.1%	20 N 5.2 – 8.2%	30 N 9.5 – 13%
PU elastic + SI conveying side	- ground - non-porous ply on PU - sealed surface SI - low-friction coating PU	Rubber cords/ Cotton	Polyurethane 55 ±7 ShA Silicone 30 ±5 ShA	PU = yellow, grey white, red SI = white, grey	300 N	10 N 1.9 – 2.1%	20 N 5.8 – 6.2%	30 N 9.6 – 10%
PU elastic 13	- coated on one side - coated on both sides - ground - non-porous ply - low-friction coating	Rubber cords/ Cotton	Polyurethane 55 ±7 ShA	yellow, grey white, red	200 N	10 N 1.9 – 2.1%	20 N 5.8 – 6.2%	30 N 9.6 – 10.4%
PU 4/6	- coated on one side - coated on both sides - ground - non-porous ply - low-friction coating	Polyester	Polyurethane 55 ±7 ShA	yellow, grey white, red	650 N	30 N 0.1 – 0.2%	100 N 0.6 – 0.8%	300 N 3.3 – 3.7%
PU 10	- coated on one side - coated on both sides - ground - non-porous ply - low-friction coating	Polyester/ Polyamide	Polyurethane 55 ±7 ShA	yellow, grey white, red	700 N	30 N 0.2 – 0.3%	60 N 0.5 – 0.6%	100 N 0.9 – 1.2%
PU 11	- coated on one side - coated on both sides - ground - non-porous ply - spec. grinding, low-frict. coat.	Polyester	Polyurethane 55 ±7 ShA	yellow, grey white, red	1250 N	100 N 0.3 – 0.5%	300 N 1.2 – 1.7%	600 N 5.0 – 5.5%
PU 12	- coated on one side - coated on both sides - ground - non-porous ply - spec. grinding, low-frict. coat.	Polyester	Polyurethane 55 ±7 ShA	yellow, grey white, red	3400 N	100 N 0.3 – 0.5%	300 N 0.9 – 1.2%	600 N 2.0 – 2.8%
PU 17	- coated on one side - coated on both sides - ground - non-porous ply - spec. grinding, low-frict. coat.	Aramide	Polyurethane 55 ±7 ShA	yellow, grey white, red	2400 N	300 N 0.2 – 0.4%	600 N 0.5 – 0.7%	1000 N 1.0 – 1.2%
PU 18	- coated on one side - coated on both sides - coated - non-porous ply - spec. grinding, low-frict. coat.	Aramide	Polyurethane 55 ±7 ShA	yellow, grey white, red	6400 N	300 N 0.4 – 0.5%	600 N 0.7 – 0.8%	1000 N 0.9 – 1.0%
PU 20/1	- ground - textile side raw - non-porous ply	Polyester/ Cotton	Polyurethane 55 ±7 ShA	yellow, grey white, red	1150 N	30 N 0.1 – 0.2%	100 N 0.5 – 0.7%	300 N 2.1 – 2.6%
PU 20	- coated on one side - coated on both sides - ground - non-porous ply - spec. grinding, low-frict. coat.	Polyester/ Cotton	Polyurethane 55 ±7 ShA	yellow, grey white, red	850 N	30 N 0.1 – 0.2%	100 N 0.5 – 0.7%	300 N 2.1 – 2.6%

Tensile force for 1% elongation per cm endless	Smallest pulley diameter	Permissible operating temperature		Recommended pre-tension	Antistatic	Coefficient of friction [$\mu \pm 0,1\mu$]						
		continuous	short-term			Steel	Aluminium	Aluminium anodised	high-grade steel	slider bed S-Green	Paper	Cast iron (GG25)
4 ±2 N	8 mm	-10 to +60°C	-10 to +80°C	4% – 8%	no	0.4	0.4	0.8	0.3	0.2	0.8	0.4
6 ±3 N	25 mm	-10 to +60°C	-10 to +80°C	4% – 8%	possible	PU 0.4 textile 0.2	PU 0.4 textile 0.2	PU 0.8 textile 0.3	PU 0.3 textile 0.2	PU 0.2 textile 0.1	PU 0.8 textile 0.3	PU 0.4 textile 0.2
9 ±3 N	30 mm	-10 to +60°C	-10 to +80°C	4% – 8%	possible	PU 0.4 SI 0.4	PU 0.4 SI 0.4	PU 0.8 SI 0.6	PU 0.3 SI 0.3	PU 0.2 SI 0.2	PU 0.8 SI 0.6	PU 0.4 SI 0.5
8 ±2 N	25 mm	-10 to +60°C	-10 to +80°C	4% – 8%	possible	PU 0.4 textile 0.2	PU 0.4 textile 0.2	PU 0.8 textile 0.3	PU 0.3 textile 0.2	PU 0.2 textile 0.1	PU 0.8 textile 0.3	PU 0.4 textile 0.2
130 ±15 N	9 mm	-10 to +60°C	-10 to +80°C	0.4% – 0.8%	possible	PU 0.4	PU 0.4	PU 0.8	PU 0.3	PU 0.2	PU 0.8	PU 0.4
100 ±15 N	8 mm	-10 bis +60°C	-10 to +80°C	1.2% – 1.5%	possible	PU 0.4	PU 0.4	PU 0.8	PU 0.3	PU 0.2	PU 0.8	PU 0.4
230 ±30 N	12 mm	-10 to +60°C	-10 to +80°C	0.4% – 0.8%	possible	PU 0.4	PU 0.4	PU 0.8	PU 0.3	PU 0.2	PU 0.8	PU 0.4
290 ±30 N	20 mm	-10 to +60°C	-10 to +80°C	0.4% – 0.8%	possible	PU 0.4 textile 0.2	PU 0.4 textile 0.2	PU 0.8 textile 0.3	PU 0.3 textile 0.2	PU 0.2 textile 0.1	PU 0.8 textile 0.3	PU 0.4 textile 0.2
950 ±50 N	15 mm	-10 to +60°C	-10 to +80°C	0.1% – 0.3%	possible	PU 0.4 textile 0.2	PU 0.4 textile 0.2	PU 0.8 textile 0.3	PU 0.3 textile 0.2	PU 0.2 textile 0.1	PU 0.8 textile 0.3	PU 0.4 textile 0.2
1280 ±50 N	30 mm	-10 to +60°C	-10 to +80°C	0.1% – 0.3%	possible	PU 0.4 textile 0.2	PU 0.4 textile 0.2	PU 0.8 textile 0.3	PU 0.3 textile 0.2	PU 0.2 textile 0.1	PU 0.8 textile 0.3	PU 0.4 textile 0.2
165 ±15 N	9 mm	-10 to +60°C	-10 to +80°C	0.4% – 0.8%	possible	PU 0.4 textile 0.1	PU 0.4 textile 0.2	PU 0.8 textile 0.3	PU 0.3 textile 0.1	PU 0.2 textile 0.1	PU 0.8 textile 0.3	PU 0.4 textile 0.2
165 ±15 N	5 mm	-10 to +60°C	-10 to +80°C	0.4% – 0.8%	possible	PU 0.4	PU 0.4	PU 0.8	PU 0.3	PU 0.2	PU 0.8	PU 0.4

Properties	Standard manufacturing dimensions **			Standard tolerances **		
	Length	Width	Thickness (max.)	Length	Width	Thickness
- highly elastic - for fixed shaft centers - belts used as sets - friction lining	200 – 600 600 – 2400	up to 300 up to 400	0.9 1.2 (from 1000 mm) 1.5 (from 1500 mm) 2.0 (from 2000 mm) (8.0)	±2.0%	up to 50 mm = ±0.5 mm up to 100 mm = ±1.0 mm from 100 mm = ±2.0 mm	±0.1 mm
- elastic - for fixed shaft centers - belts used as sets	200 – 600 600 – 3500	up to 300 up to 600	1.8 (9.0)	±2.0%	up to 50 mm = ±0.5 mm up to 100 mm = ±1.0 mm from 100 mm = ±2.0 mm	±0.1 mm
- elastic - for fixed shaft centers - different values of coefficient of friction - belts used as sets	200 – 600 600 – 3500	up to 300 up to 600	2.4 (10.0)	±2.0%	up to 50 mm = ±0.5 mm up to 100 mm = ±1.0 mm from 100 mm = ±2.0 mm	±0.1 mm
- elastic - for fixed shaft centers - belts used as sets	200 – 600 600 – 3500	up to 300 up to 600	1.5 (10.0)	±2.0%	up to 50 mm = ±0.5 mm up to 100 mm = ±1.0 mm from 100 mm = ±2.0 mm	±0.1 mm
- accum. conveyor bands - paper transport - very flexible	200 – 600 600 – 4400	up to 300 up to 600	0.8 (10.0)	±0.5%	up to 50 mm = ±0.5 mm up to 100 mm = ±1.0 mm from 100 mm = ±2.0 mm	±0.1 mm
- slightly elastic - for fixed shaft centers - belts used as sets	200 – 600 600 – 4400	up to 300 up to 600	0.9 (10.0)	±0.5%	up to 50 mm = ±0.5 mm up to 100 mm = ±1.0 mm from 100 mm = ±2.0 mm	±0.1 mm
- length up to 2400 mm available ex-stock - very good running characteristics - universal application	200 – 600 600 – 5000	up to 300 up to 600	1.0 (10.0)	±0.5%	up to 50 mm = ±0.5 mm up to 100 mm = ±1.0 mm from 100 mm = ±2.0 mm	±0.1 mm
- length up to 2400 mm available ex-stock - universal application - medium-duty drives	200 – 600 600 – 4800	up to 300 up to 600	1.5 (10.0)	±0.5%	up to 50 mm = ±0.5 mm up to 100 mm = ±1.0 mm from 100 mm = ±2.0 mm	±0.1 mm
- very low elongation	200 – 600 600 – 4600	up to 300 up to 600	1.0 (10.0)	±1.0%	up to 50 mm = ±0.5 mm up to 100 mm = ±1.0 mm from 100 mm = ±2.0 mm	±0.1 mm
- extremely low elongation - heavy-duty drives	200 – 600 600 – 4200	up to 300 up to 600	2.2 (10.0)	±1.0%	up to 100 mm = ±1.0 mm from 100 mm = ±2.0 mm	±0.1 mm
- slider beds - knife edge - low coefficient of friction on textile side	200 – 600 600 – 4200	up to 300 up to 600	0.9 (10.0)	±0.5%	up to 50 mm = ±0.5 mm up to 100 mm = ±1.0 mm from 100 mm = ±2.0 mm	±0.1 mm
- thin, highly flexible band	200 – 600 600 – 4200	up to 300 up to 600	0.8 (10.0)	±0.5%	up to 50 mm = ±0.5 mm up to 100 mm = ±1.0 mm from 100 mm = ±2.0 mm	±0.1 mm

* The standard hardness of PU coating is approx. 55° Shore A.

The following options are possible:

PU red hard = approx. 70° ± 7° Shore A

PU grey hard = approx. 70° ± 7° Shore A

PU yellow soft = approx. 30° ± 7° Shore A

Altering the surface also means altering the coefficient of friction, thickness and thickness tolerances.

** Other dimensions and tolerances available on request.

Length tolerances below ± 2.5 mm not possible.

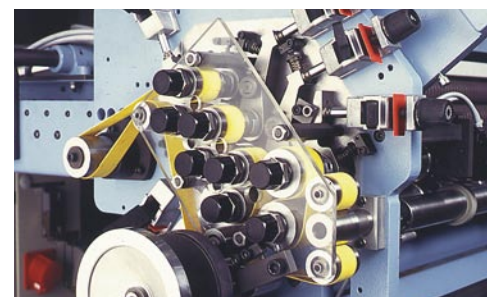

Foamed Polyurethane (PU)

Colours: Yellow, grey, white, red

**Temperature-resistant up to 60°C,
short-term up to 80°C**

**Very good coefficient of friction
against paper**

Different hardness versions possible

Thickness up to max. 10 mm possible

Non-porous finish

**Colours: Yellow, black, white, red,
grey**

Stain-resistant and easier to clean

**Reduced coefficient of friction possible
(non-porous ply SL)**



NE types	Esband type	Surface options	Tensile element	Coating/ Hardness	Colours	Breaking strength per cm endless	Belt elongation [%] per cm endless at tensile force (axle load)		
	NE Mini	- profiled on one side - smooth on one side	Polyester	Polychloroprene 75 ±5 ShA	black	550 N	30 N 0.1 – 0.3%	100 N 0.5 – 0.7%	300 N 3.5 – 3.9%
	NE 10	- profiled on both sides - smooth on one side	Polyamide/ Polyester	Polychloroprene 75 ±5 ShA	black	750 N	30 N 0.2 – 0.4%	100 N 1.1 – 1.5%	300 N 6.8 – 7.8%
	NE 10/133	- profiled or smooth on one side - second side textile impregnated	Polyamide/ Polyester	Polychloroprene 75 ±5 ShA	black	700 N	30 N 0.3 – 0.5%	100 N 1.3 – 1.6%	300 N 8.2 – 8.5%
	NE 17	- profiled on one side, smooth on one side - ground on both sides	Aramide	Polychloroprene 75 ±5 ShA	black	2400 N	300 N 0.2 – 0.4%	600 N 0.5 – 0.7%	1000 N 0.9 – 1.1%
	NE 17/133	- profiled or smooth on one side - second side textile impregnated	Aramide	Polychloroprene 75 ±5 ShA	black	2400 N	300 N 0.2 – 0.4%	600 N 0.5 – 0.7%	1000 N 0.9 – 1.1%
	NE 18	- profiled on both sides, smooth on one side - ground on both sides	Aramide	Polychloroprene 75 ±5 ShA	black	7950 N	300 N 0.2 – 0.3%	600 N 0.4 – 0.5%	1000 N 0.6 – 0.7%
	NE 18 GA V 10535	- ground on both sides	Aramide	Polychloroprene 75 ±5 ShA	black	11340 N	300 N 0.1 – 0.3%	600 N 0.3 – 0.5%	1000 N 0.5 – 0.7%
	NE 20	- profiled on both sides - smooth on one side	Polyester/ Cotton	Polychloroprene 75 ±5 ShA	black	950 N	100 N 0.4 – 0.6%	300 N 1.8 – 2.0%	600 N 5.5 – 5.9%
	NE 20/133	- profiled on one side - second side textile impregnated	Polyester/ Cotton	Polychloroprene 75 ±5 ShA	black	950 N	100 N 0.4 – 0.6%	300 N 1.8 – 2.0%	600 N 5.5 – 5.9%
	NE 20/1	- ground, smooth - profiled - textile side raw	Polyester/ Cotton	Polychloroprene 75 ±5 ShA	black	950 N	100 N 0.4 – 0.6%	300 N 1.8 – 2.0%	600 N 5.5 – 5.9%
	NE 21	- profiled on both sides - smooth on one side - ground on one or both sides	Polyester	Polychloroprene 75 ±5 ShA	black	1700 N	100 N 0.3 – 0.4%	300 N 1.0 – 1.2%	600 N 4.0 – 4.5%
	NE 21/133	- profiled on one side or smooth - second side textile impregnated	Polyester	Polychloroprene 75 ±5 ShA	black	1700 N	100 N 0.3 – 0.4%	300 N 1.0 – 1.2%	600 N 4.0 – 4.5%
	NE 22	- profiled on both sides - smooth on one side - ground on one or both sides	Polyester	Polychloroprene 75 ±5 ShA	black	3400 N	100 N 0.2 – 0.3%	300 N 0.7 – 0.8%	600 N 1.6 – 1.7%
	NE 26	- profiled on both sides - smooth on one side - ground on one or both sides	Polyester	Polychloroprene 75 ±5 ShA	black	4150 N	300 N 0.8 – 0.9%	600 N 1.4 – 1.6%	1000 N 3.0 – 3.4%
	NE 133 SB	- profiled on one side - second side textile impregnated	Polyester/ Cotton	Polychloroprene 75 ±5 ShA	black	2100 N	30 N 0.0 – 0.1%	300 N 0.5 – 0.7%	600 N 1.6 – 2.0%
	NE 133/1	- profiled on one side - second side textile raw	Polyester/ Cotton	Polychloroprene 75 ±5 ShA	black	2100 N	30 N 0.0 – 0.1%	300 N 0.5 – 0.7%	600 N 1.6 – 2.0%
	NE Elastic	- ground	without carcass	Polychloroprene 75 ±5 ShA	black	on request	5 N 1.5 – 2.5%	15 N 8.0 – 12.0%	30 N 26.0 – 34.0%

Properties	Standard manufact. dimensions [mm] *			Standard tolerances *		
	Length	Width	Thickness	Length	Width	Thickness
- for miniature drives	120 – 330	up to 150	0.5	±0.5%	up to 50 mm = ±0.5 mm up to 100 mm = ±1.0 mm over 100 mm = ±2.0 mm	±0.15 mm
- slightly elastic - for fixed shaft centres - belts used as sets	400 – 2000	5 – 420	0.8	±0.5%	up to 50 mm = ±0.5 mm up to 100 mm = ±1.0 mm over 100 mm = ±2.0 mm	±0.15 mm
- pulley side textile impregnated and low coefficient of friction	400 – 2000	5 – 420	0.7	±0.5%	up to 50 mm = ±0.5 mm up to 100 mm = ±1.0 mm over 100 mm = ±2.0 mm	±0.15 mm
- drive belt - very low elongation	400 – 4600	up to 420	0.9	±1.0%	up to 50 mm = ±0.5 mm up to 100 mm = ±1.0 mm over 100 mm = ±2.0 mm	±0.15 mm
- drive belt with different coefficients of friction - very low elongation	250 – 400 400 – 4600	up to 350 up to 420	0.8	±1.0%	up to 50 mm = ±0.5 mm up to 100 mm = ±1.0 mm over 100 mm = ±2.0 mm	±0.15 mm
- extremely low elongation - heavy-duty drives	400 – 4200	up to 420	2.0	±1.0%	up to 100 mm = ±1.0 mm over 100 mm = ±2.0 mm	±0.15 mm
- extremely low elongation - heavy-duty drives	1800 – 9000	10 – 280	3.0	±1.0%	up to 100 mm = ±1.0 mm over 100 mm = ±2.0 mm	±0.1 mm
- very flexible - good running characteristics	400 – 4200	up to 420	0.8	±0.5%	up to 50 mm = ±0.5 mm up to 100 mm = ±1.0 mm over 100 mm = ±2.0 mm	±0.15 mm
- different coefficients of friction - very flexible	200 – 400 400 – 4200	up to 350 up to 400	0.7	±0.5%	up to 50 mm = ±0.5 mm up to 100 mm = ±1.0 mm over 100 mm = ±2.0 mm	±0.15 mm
- slider beds, knife edge - low coefficient of friction on textile side	200 – 400 400 – 4200	up to 350 up to 420	0.8	±0.5%	up to 50 mm = ±0.5 mm up to 100 mm = ±1.0 mm over 100 mm = ±2.0 mm	±0.15 mm
- high belt running speeds - very good running characteristics - universal application	400 – 4800	up to 420	0.9	±0.5%	up to 50 mm = ±0.5 mm up to 100 mm = ±1.0 mm over 100 mm = ±2.0 mm	±0.15 mm
- different coefficients of friction - very good running characteristics	250 – 400 400 – 4800	up to 350 up to 420	0.8		up to 50 mm = ±0.5 mm up to 100 mm = ±1.0 mm over 100 mm = ±2.0 mm	±0.15 mm
- lengths up to 2400mm avail. ex-stock - universal application - medium-duty drives	400 – 4800	up to 420	1.4	±0.5%	up to 50 mm = ±0.5 mm up to 100 mm = ±1.0 mm over 100 mm = ±2.0 mm	±0.15 mm
- heavy-duty drives	400 – 4800	up to 420	2.0	±0.5%	up to 100 mm = ±1.0 mm over 100 mm = ±2.0 mm	±0.15 mm
- spindle drive	400 – 4400	up to 420	1.3	±0.5%	up to 50 mm = ±0.5 mm up to 100 mm = ±1.0 mm over 100 mm = ±2.0 mm	±0.15 mm
- table remover - difficult transportation	400 – 4400	up to 420	1.2	±0.5%	up to 50 mm = ±0.5 mm up to 100 mm = ±1.0 mm over 100 mm = ±2.0 mm	±0.15 mm
- highly elastic - for fixed shaft centres - high friction coating for pulleys - belts used as sets	150 – 2000	up to 200	0.8 – 5.0	±1.0%	up to 50 mm = ±0.5 mm up to 100 mm = ±1.0 mm over 100 mm = ±2.0 mm	±0.1 mm

* Other dimensions and tolerances available on request.

Length tolerances below ± 2.5 mm not possible.



Neoprene Rubber

Black, electrically conductive

Temperature-resistant up to 100°C

Hardness approx. 75° ShA

High coefficient of friction

High resistance to abrasion

Good resistance to oils, grease, ozone

Flexible

Natural Rubber

Red (hardness approx. 42° ShA)

Maroon (hardness approx. 50° ShA)

Temperature-resistant up to 70°C

Extremely high coefficient of friction

Highly elastic

High resistance to tear propagation

NBR Rubber

Light grey, blue, white

FDA/BGA approved (white only)

Temperature-resistant up to 100°C

High resistance to abrasion:
hardness approx. 70° ShA

Resistant to ozone

Extremely good resistance to
oils and grease

xNBR Rubber

Off-white

Hardness approx. 75° ShA

Temperature-resistant up to 130°C

Good coefficient of friction

Extremely high resistance to abrasion

Resistant to ozone

Extremely good resistance to
oils and grease

EPDM

Green

Hardness approx. 65° ShA

Very durable in extreme climates

Temperature-resistant up to 80°C

Good coefficient of friction

Only available as elastic belt without
carcass and as coating on timing belts

FX | SI | PC

FX type	Esband type	Surface options	Tensile element	Coating/ Hardness	Colours	Breaking strength per cm endless	Belt elongation [%] per cm endless at tensile force (axle load)		
							100 N	300 N	400 N
FX type	FX 05 white	- smooth, ground - T-profile	Polyamide/Polyester	Polyurethane 80 ±5 ShA	white	450 N	100 N 1.1 – 1.3%	300 N 4.6 – 5.2%	400 N 6.3 – 7.0%
	FX 10 coated on both sides	- pulley side ground - conveying side profiled	Polyamide/Polyester	Polyurethane 80 ±5 ShA	white	750 N	30 N 0.3 – 0.5%	100 N 2.2 – 2.6%	300 N 8.8 – 9.3%
	FX 11	- pulley side textile - conveying side ground	Polyester	Polyurethane 80 ±5 ShA	white	1000 N	100 N 0.3 – 0.5%	300 N 1.3 – 1.7%	600 N 5.0 – 5.8%
	FX 11 coated on both sides	- pulley side smooth - conveying side profiled	Polyester	Polyurethane 80 ±5 ShA	white	1000 N	100 N 0.3 – 0.5%	300 N 1.3 – 1.7%	600 N 5.0 – 5.8%
	FX 17 coated on both sides	- pulley side smooth - conveying side profiled	Aramide	Polyurethane 80 ±5 ShA	white	2300 N	300 N 0.3 – 0.4%	600 N 0.6 – 0.7%	1000N 0.9 – 1.0%
	FX 20	- pulley side textile - conveying side ground	Polyester/ Cotton	Polyurethane 80 ±5 ShA	white	1360 N	30 N 0.1 – 0.2%	100 N 0.5 – 0.7%	300 N 2.1 – 2.6%
	FX 20 coated on both sides	- pulley side ground - conveying side ground	Polyester/ Cotton	Polyurethane 80 ±5 ShA	white	1300 N	100 N 0.6 – 0.7%	300 N 1.8 – 2.0%	600 N 4.6 – 5.1%
Silicone types	SI 1	- coated on one side - coated on both sides - ground - sealed surface SI	Polyester	Silicone 30 ±5 ShA	white, grey	1450 N	100 N 0.3 – 0.5%	300 N 2.0 – 2.2%	600 N 6.6 – 7.0%
	SI 3	- coated on one side - coated on both sides - ground - sealed surface SI	Polyester/ Cotton	Silicone 30 ±5 ShA	white, grey	800 N	30 N 0.0 – 0.2%	300 N 1.4 – 1.6%	600 N 4.3 – 4.7%
	HN 1	- coated on one side - coated on both sides - ground - sealed surface SI	Nomex	Silicone 30 ±5 ShA	white, grey	820 N	30 N 0.0 – 0.1%	300 N 1.8 – 2.2%	600 N 7.5 – 8.5%
	HG 1	- coated on one side - coated on both sides - ground - sealed surface SI	Glass fibre	Silicone 30 ±5 ShA	white, grey	1080 N	30 N 0.0 – 0.1%	300 N 0.5 – 0.7%	600 N 0.8 – 1.2%
	HK 17	- coated on one side - coated on both sides - ground - sealed surface SI	Aramide	Silicone 30 ±5 ShA	white, grey	1700 N	300 N 0.9 – 1.2%	600 N 1.4 – 1.7%	1000 N 1.9 – 2.2%
	HK 18	- coated on one side - coated on both sides - ground - sealed surface SI	Aramide	Silicone 30 ±5 ShA	white, grey	5800 N	300 N 0.3 – 0.5%	600 N 0.5 – 0.8%	1000 N 0.9 – 1.0%
PVC types	PC	- one side impregnated - one side profiled	Polyester/ Cotton	PVC 50 ±10 ShA	red	2750 N	100 N 0.0 – 0.1%	300 N 0.6 – 0.8%	600 N 1.5 – 1.8%
	PC 1	- one side PVC-coated, profiled - one side carcass, raw	Polyester/ Cotton	PVC 50 ±10 ShA	red	2750 N	100 N 0.0 – 0.1%	300 N 0.6 – 0.8%	600 N 1.5 – 1.8%
	PC 1 + SI conveying side	- one side PVC-profiled - one side SI ground	Polyester/ Cotton	PVC 50 ±10 ShA	red/white	2750 N	100 N 0.0 – 0.1%	300 N 0.6 – 0.8%	600 N 1.5 – 1.8%
	PC 1 + PU conveying side	- one side PVC-profiled - one side PU ground	Polyester/ Cotton	PVC 50 ±10 ShA	red/yellow	2750 N	100 N 0.0 – 0.1%	300 N 0.6 – 0.8%	600 N 1.5 – 1.8%

Tensile force for 1% elongation per cm endless	Smallest pulley diameter	Permissible operating temperature		Antistatic	Coefficient of friction [$\mu \pm 0,1\mu$]					
		continuous	short-term		Steel	Aluminium anodised	Aluminium	high-grade Steel	slidet beb S-Green	Paper
90 ±10 N	6 mm	-10 to +80°C	-10 to +80°C	possible	smooth 0.5 ground 0.4 T-profile 0.3	smooth 0.4 ground 0.3 T-profile 0.4	smooth 0.5 ground 0.4 T-profile 0.5	smooth 0.4 ground 0.2 T-profile 0.2	smooth 0.1 ground 0.2 T-profile 0.1	smooth 0.4 ground 0.7 T-profile 0.6
55 ±10 N	15 mm	-10 to +80°C	-10 to +80°C	possible	ground 0.4 T-profile 0.3	ground 0.3 T-profile 0.4	ground 0.4 T-profile 0.5	ground 0.2 T-profile 0.2	ground 0.2 T-profile 0.1	ground 0.7 T-profile 0.6
230 ±20 N	10 mm	-10 to +80°C	-10 to +80°C	possible	ground 0.4	ground 0.3	ground 0.4	ground 0.2	ground 0.2	ground 0.7
230 ±20 N	20 mm	-10 to +80°C	-10 to +80°C	possible	smooth 0.5 profiled 0.3	smooth 0.4 profiled 0.4	smooth 0.5 profiled 0.5	smooth 0.4 profiled 0.2	smooth 0.1 profiled 0.1	smooth 0.4 profiled 0.6
1040 ±50 N	20 mm	-10 to +80°C	-10 to +80°C	possible	smooth 0.5 profiled 0.3	smooth 0.4 profiled 0.4	smooth 0.5 profiled 0.5	smooth 0.4 profiled 0.2	smooth 0.1 profiled 0.1	smooth 0.4 profiled 0.6
165 ±15 N	15 mm	-10 to +80°C	-10 to +80°C	possible	ground 0.4	ground 0.3	ground 0.4	ground 0.2	ground 0.2	ground 0.7
170 ±15 N	15 mm	-10 to +80°C	-10 to +80°C	possible	ground 0.4	ground 0.3	ground 0.4	ground 0.2	ground 0.2	ground 0.7
190 ±20 N	12 mm	-20 to +150°C	-20 to +180°C	possible	SI 0.4 textile 0.2 cover. skin 0.7	SI 0.4 textile 0.2 cover. skin 0.8	SI 0.6 textile 0.3 cover. skin 0.9	SI 0.3 textile 0.2 cover. skin 0.5	SI 0.2 textile 0.1 cover. skin 0.4	SI 0.6 textile 0.3 cover. skin 0.9
135 ±15 N	10 mm	-20 to +120°C	-20 to +160°C	possible	SI 0.4 textile 0.1 cover. skin 0.7	SI 0.4 textile 0.2 cover. skin 0.8	SI 0.6 textile 0.3 cover. skin 0.9	SI 0.3 textile 0.1 cover. skin 0.5	SI 0.2 textile 0.1 cover. skin 0.4	SI 0.6 textile 0.3 cover. skin 0.9
170 ±20 N	20 mm	-50 to +200°C	-60 to +250°C	possible	SI 0.4 textile 0.2 cover. skin 0.7	SI 0.4 textile 0.2 cover. skin 0.8	SI 0.6 textile 0.3 cover. skin 0.9	SI 0.3 textile 0.2 cover. skin 0.5	SI 0.2 textile 0.1 cover. skin 0.4	SI 0.6 textile 0.3 cover. skin 0.9
600 ±50 N	20 mm	-60 to +250°C	-60 to +280°C	possible	SI 0.4 textile 0.2 cover. skin 0.7	SI 0.4 textile 0.2 cover. skin 0.8	SI 0.6 textile 0.3 cover. skin 0.9	SI 0.3 textile 0.2 cover. skin 0.5	SI 0.2 textile 0.1 cover. skin 0.4	SI 0.6 textile 0.3 cover. skin 0.9
290 ±50 N	20 mm	-50 to +250°C	-50 to +280°C	possible	SI 0.4 textile 0.2 cover. skin 0.7	SI 0.4 textile 0.2 cover. skin 0.8	SI 0.6 textile 0.3 cover. skin 0.9	SI 0.3 textile 0.2 cover. skin 0.5	SI 0.2 textile 0.1 cover. skin 0.4	SI 0.6 textile 0.3 cover. skin 0.9
990 ±100 N	20 mm	-50 to +250°C	-50 to +280°C	possible	SI 0.4 textile 0.2 cover. skin 0.7	SI 0.4 textile 0.2 cover. skin 0.8	SI 0.6 textile 0.3 cover. skin 0.9	SI 0.3 textile 0.2 cover. skin 0.5	SI 0.2 textile 0.1 cover. skin 0.4	SI 0.6 textile 0.3 cover. skin 0.9
380 ±30 N	15 mm	-10 to +60°C	-10 to +80°C	no	PVC 0.7	PVC 0.8	PVC >0.9	PVC 0.6	PVC 0.4	PVC 0.9
380 ±30 N	12 mm	-10 to +60°C	-10 to +80°C	no	PVC 0.7 carcass 0.1	PVC 0.8 carcass 0.2	PVC >0.9 carcass 0.3	PVC 0.6 carcass 0.1	PVC 0.4 carcass 0.1	PVC 0.9 carcass 0.3
380 ±30 N	25 mm	-10 to +60°C	-10 to +80°C	no	PVC 0.7 SI 0.4	PVC 0.8 SI 0.4	PVC >0.9 SI 0.6	PVC 0.6 SI 0.3	PVC 0.4 SI 0.2	PVC 0.9 SI 0.6
380 ±30 N	25 mm	-10 to +60°C	-10 to +80°C	no	PVC 0.7 PU 0.4	PVC 0.8 PU 0.4	PVC >0.9 PU 0.8	PVC 0.6 PU 0.3	PVC 0.4 PU 0.3	PVC 0.9 PU 0.8

Properties	Standard manufacturing dimensions [mm] *			Standard tolerances *		
	Length	Width	Thickness (max.)	Length	Width	Thickness
- very thin and flexible - FDA/BGA	480 – 4800	5 – 900	0.5	±0.5%	up to 50 mm = ±0.5 mm up to 100 mm = ±1.0 mm over 100 mm = ±2.0 mm	±0.15 mm
- slightly elastic belt - FDA/BGA	480 – 4000	5 – 900	1.0	±0.5%	up to 50 mm = ±0.5 mm up to 100 mm = ±1.0 mm over 100 mm = ±2.0 mm	±0.15 mm
- very good running characteristics - FDA/BGA	480 – 4000	5 – 900	1.0	±0.5%	up to 50 mm = ±0.5 mm up to 100 mm = ±1.0 mm over 100 mm = ±2.0 mm	±0.1 mm
- very good running characteristics - FDA/BGA	480 – 4000	5 – 900	1.2	±0.5%	up to 50 mm = ±0.5 mm up to 100 mm = ±1.0 mm over 100 mm = ±2.0 mm	±0.15 mm
- low elongation - FDA/BGA	480 – 4000	5 – 900	1.3	±1.0%	up to 50 mm = ±0.5 mm up to 100 mm = ±1.0 mm over 100 mm = ±2.0 mm	±0.15 mm
- table remover - FDA/BGA	480 – 4000	5 – 900	0.7 – 0.9	±0.5%	up to 50 mm = ±0.5 mm up to 100 mm = ±1.0 mm over 100 mm = ±2.0 mm	±0.1 mm
- good running characteristics - FDA/BGA	480 – 4000	5 – 900	1.0	±0.5%	up to 50 mm = ±0.5 mm up to 100 mm = ±1.0 mm over 100 mm = ±2.0 mm	±0.1 mm

Esband Endless
Conveyor belts with white Polyurethane,
FDA compliant.

* Other dimensions and tolerances
available on request.

Length tolerances below ±2,5 mm
not possible

- FDA/BGA compliant - dirt-resistant - adhesive-resistant - weighing belt	200 – 600 600 – 4800	up to 300 up to 600	1.0 (10.0)	±0.5%	up to 50 mm = ±0.5 mm up to 100 mm = ±1.0 mm over 100 mm = ±2.0 mm	±0.1 mm
- FDA/BGA compliant - dirt-resistant - highly flexible - blade edge	200 – 600 600 – 4200	up to 300 up to 600	1.0 (10.0)	±0.5%	up to 50 mm = ±0.5 mm up to 100 mm = ±1.0 mm over 100 mm = ±2.0 mm	±0.1 mm
- temperature-resistant - dirt-resistant - adhesive-resistant	200 – 600 600 – 4200	up to 300 up to 600	1.5 (10.0)	±0.5%	up to 100 mm = ±1.0 mm over 100 mm = ±2.0 mm	±0.1 mm
- temperature-resistant - dirt-resistant - adhesive-resistant - chemical-resistant	200 – 600 600 – 4200	up to 300 up to 600	1.5 (10.0)	±1.0%	up to 50 mm = ±0.5 mm up to 100 mm = ±1.0 mm over 100 mm = ±2.0 mm	±0.1 mm
- temperature-resistant - low elongation	200 – 600 600 – 4600	up to 300 up to 600	1.3 (10.0)	±1.0%	up to 50 mm = ±0.5 mm up to 100 mm = ±1.0 mm over 100 mm = ±2.0 mm	±0.1 mm
- temperature-resistant - low elongation	200 – 600 600 – 4200	up to 300 up to 600	2.0 (10.0)	±1.0%	up to 100 mm = ±1.0 mm over 100 mm = ±2.0 mm	±0.1 mm



- very good resistance to acids and alkalis - high coefficient of friction	500 – 4200	up to 400	1.1	±0.5%	up to 50 mm = ±0.5 mm up to 100 mm = ±1.0 mm over 100 mm = ±2.0 mm	±0.15 mm
- table remover - different values of coefficient of friction	500 – 4200	up to 400	1.0	±0.5%	up to 50 mm = ±0.5 mm up to 100 mm = ±1.0 mm over 100 mm = ±2.0 mm	±0.15 mm
- conveyor belt with different coefficients of friction	500 – 4200	up to 400	2.0	±0.5%	up to 50 mm = ±0.5 mm up to 100 mm = ±1.0 mm over 100 mm = ±2.0 mm	±0.15 mm
- conveyor belt with different coefficients of friction	500 – 4200	up to 400	2.0	±0.5%	up to 50 mm = ±0.5 mm up to 100 mm = ±1.0 mm over 100 mm = ±2.0 mm	±0.15 mm

Compact Polyurethane (FX)

White, hardness approx. 80° ShA

Only available in certain thicknesses

FDA/BGA approved

Temperature-resistant up to 80°C

Surface smooth, ground or profiled

Silicone

White, grey

Hardness approx. 30° – 35° ShA

Temperature-resistant up to 280°C

High coefficient of friction

Stain-resistant, resistant to chemicals

FDA/BGA approved

Thickness up to 10 mm possible

PVC

Red

Temperature-resistant up to 60°C

Resistant to chemicals

Resistant to microbes



Technical Data

Esband creates endless design possibilities. When you are a designer or machine manufacturer we can give you useful information on pulley designs, design of the belt drive, arrangement of tensioning pulleys, placement of tensioning rollers and special drive forms.

1. Guiding of the Flat Belt by Crowned Pulleys

Design of pulley depending on belt width b

b [mm]	b_s [mm]	h [mm]	r_s [mm]
10	13	0,3	71
13	16	0,3	107
16	20	0,3	167
20	25	0,3	261
25	32	0,3	427
32	40	0,4	500
40	50	0,4	782
50	63	0,4	1241
63	80	0,4	2000
80	100	0,5	2500
100	125	0,5	3907
125	160	0,6	5334
160	200	0,7	7143
200	250	0,8	9766

Textile flat belts run with a very high degree of directional stability. To ensure optimum belt guidance at least one of the pulleys should be crowned. The remaining pulleys may then be cylindrically shaped.

In case of limited production possibilities or large pulley widths, one of the other illustrated crown forms may be chosen.

Important note: To achieve optimum service life of the belt, pulleys which rotate in the same direction should be designed with a crown.

When pulleys are mounted in a parallel way and conventional drive conditions exist, lower values than the given ones for crown height may be chosen.

Recommended materials: Steel, grey cast iron or aluminium in ground or fine-ground form ($R_a = 3.2 \mu\text{m} / R_z = 16 \mu\text{m}$ or $R_a = 1.6 \mu\text{m} / R_z = 6.3 \mu\text{m}$).

We reserve the right to amend the specified values to reflect the latest state of the art.

General advantages of flat belts

Extremely high efficiency (>98.5%)

High belt speeds up to 150 m/s (low mass-centrifugal forces up to 20 m/s can be disregarded)

Machine elements in wide variety (surfaces, materials, elongation)

Long service life

Many designs and specific solutions possible

High power density (30 kW/cm, depending upon belt speed)

Very good dynamic properties (quiet running, precise tracking)

Freedom in design - simplified design

Better shock attenuation and shock absorption

Use as overload protection for expensive machine components.

Designs of the crown for guiding pulleys

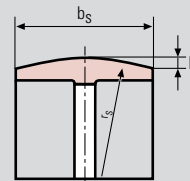

Slightly crowned

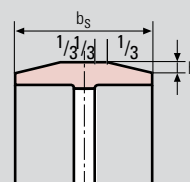

Trapezoidal crown

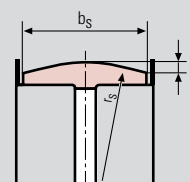

Slightly crowned with shoulders (shoulders without guide tasks)

Calculations

1. Calculations for standard drives on the basis of an example:

These calculations assume the following data:

- P = 7.5 kW
- d1 = 140 mm
- n1 = 2900 rpm
- d2 = 52 mm
- Number of pulleys z = 2
- Shaft centre distance e = 165 mm
- Belt type chosen = NE22
- Coefficient of friction = 0.5 μ
- Duty factor CB = 0.9

1.1 Belt length L =

$$2 * e + \frac{\pi}{2} (d2+d1) + \frac{(d2-d1)^2}{4 * e} = 643 \text{ mm}$$

1.2 Belt speed v =

$$\frac{d1 * n1}{19100} = 21,26 \text{ m/s}$$

1.3 Bending frequency f_B =

$$1000 * z * \frac{v}{L} = 66 \text{ 1/s}$$

Comparisons in the table showing the smallest pulley diameter.

1.4 Arc of contact β =

$$180 - \frac{60 * |d1-d2|}{e} = 148^\circ$$

1.5 Specific rated power P_N

According to diagram:
2.3 kW per cm of belt width

1.6 Belt width b =

$$\frac{10 * P}{C_B * P_N} = 36,2 \text{ mm} = 40 \text{ mm}$$

1.7 Strand force ratio m =

$$\text{(Euler's number)} \mu^{\widehat{\beta}} = 3.64$$

1.8 Minimum pre-tension F_v =

$$\frac{m+1}{m-1} * \frac{500 * P}{v} + \frac{1,21 * b * v^2}{1000} = 331,9 \text{ N}$$

1.9 Shaft force at idle F_w =

$$2 * F_v * \sin \frac{\beta}{2} = 638,1 \text{ N}$$

1.10 Suggested text when placing an order:

Esband NE 22; 643 x 40 mm, or closest stock dimension = 650 x 40 mm

2. Selecting the duty factor C_B

1.0

Steady operation, small mass to be accelerated

0.9

Almost steady operation, medium mass to be accelerated

0.75

Non-steady operation, medium mass to be accelerated

0.65

Non-steady operation, large mass to be accelerated, heavy shocks

3. Relation between transmittable power and belt speed

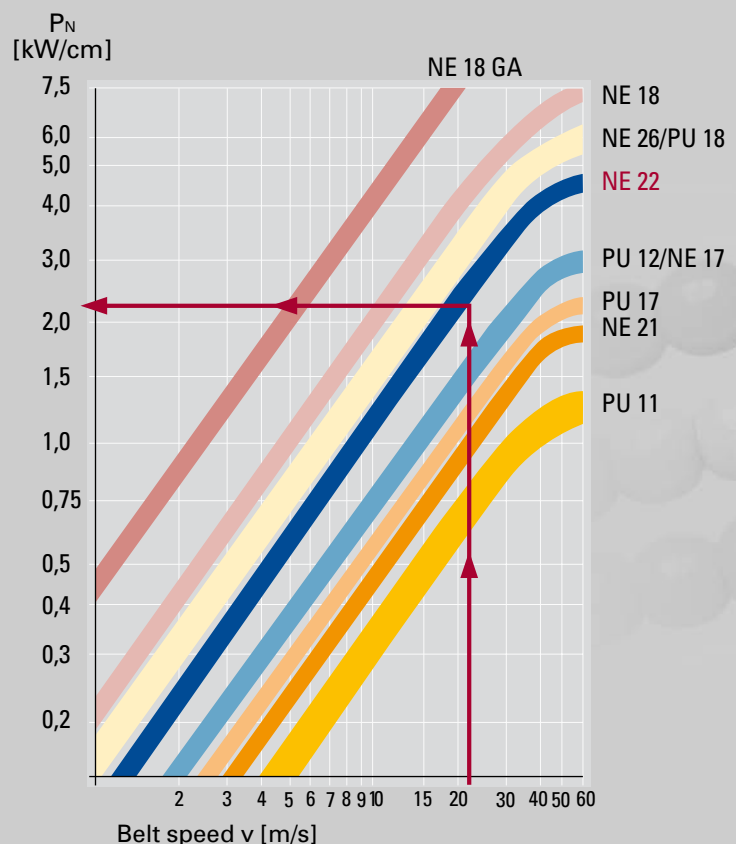

4. Determining the bending frequency

Guide values for maximum bending frequency and minimum pulley diameter for endless Schlatterer drive belts with standard thickness.

Pulley diameter

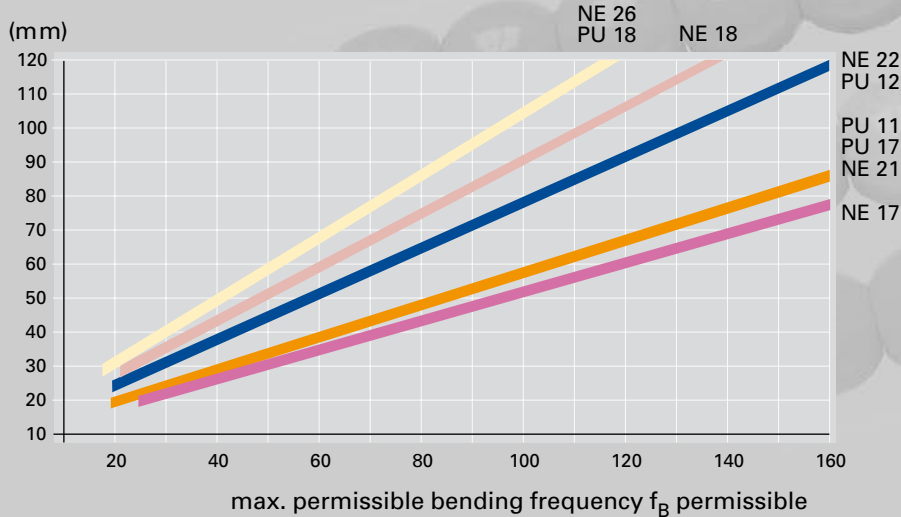

Ground NE belt and PU belts, the latter coated on both sides
 f_B permissible = 15% less

5. Equations for special forms of drive

Cross belt drive

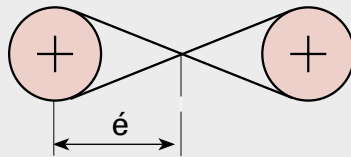

Determining the shaft centre distance:

$$\acute{e}/ab \geq 20$$

Calculating the belt length:

$$L = 4 \cdot \acute{e} + \frac{\pi}{2} (d_1 + d_2) + \frac{(d_1 + d_2)^2}{8 \cdot \acute{e}}$$

Half-cross belt drive

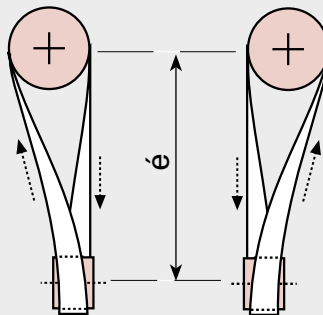

Determining the shaft centre distance:

$$\acute{e}/ab \geq 20$$

Calculating the belt length:

$$L = 2 \cdot \acute{e} + \frac{\pi}{2} (d_1 + d_2) + \frac{d_1^2 + d_2^2}{4 \cdot \acute{e}}$$

90° turn belt drive

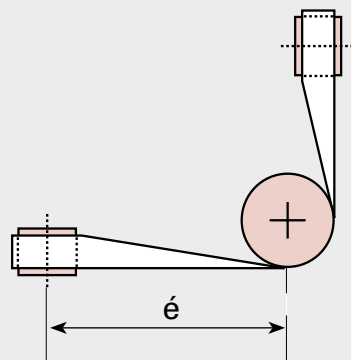

Determining the shaft centre distance:

$$\acute{e}/ab \geq 20$$

Calculating the belt length:

$$L = 4 \cdot \acute{e} + \frac{\pi}{2} (d_1 + d_2 + d_3) + \frac{d_1^2 + d_2^2}{8 \cdot \acute{e}}$$

For Designers

Fig. 1

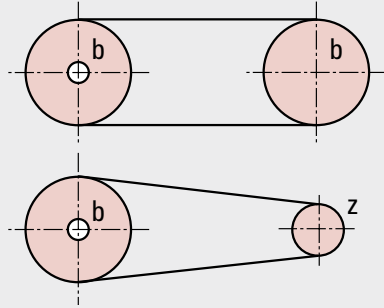
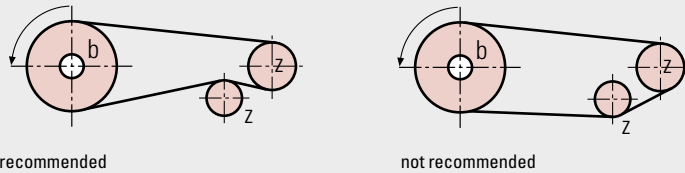
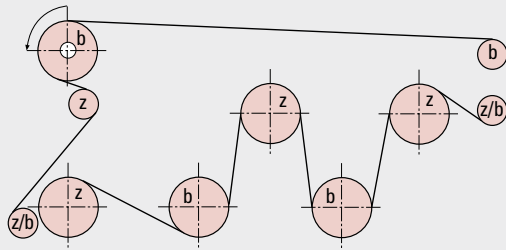

Fig. 2



recommended

not recommended

2. Design of the belt drive with crowned/cylindrical pulleys

With gearing ratios exceeding 1:3 and horizontal shafts, the crown of the small pulley may be cylindrical. In the case of drives with vertical shafts we recommend to crown both pulleys (see Fig. 1).

For multi-shaft belt drives the pulleys with the biggest diameter and rotating in the same sense must be crowned (see Fig. 2).

3. Arrangement of tensioning rollers

When using tensioning rollers the following items must be observed:

- The diameter of the tensioning roller should be selected as large as possible
- The tensioning roller should always be in the slack side of the drive
- The tensioning roller should always be cylindrical
- The necessary pre-tension can be applied by using tensioning rollers, motor-driven rocker dolly switch, eccentric, spring tension or the inherent elasticity of the belt.

Knife edge

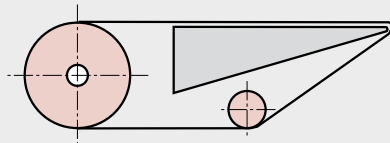

Vacuum box

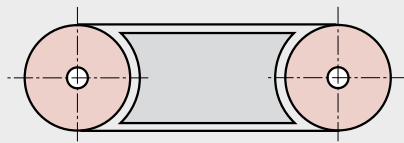

Checkweigher

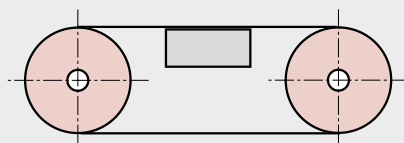

Properties of conveyor belts for applications on the left hand side

- Low coefficient of friction on running side
- Belt thickness as thin as possible (especially knife edges and weighing belts)
- If necessary, increase coefficient of friction on the pulley (rubber coating on pulley)
- Type of goods to be transported (food)
- Resistance to chemicals
- Antistatic (carcass)
- Self-tracking guide with guide wedges (not for knife edges!)

Quality Assurance

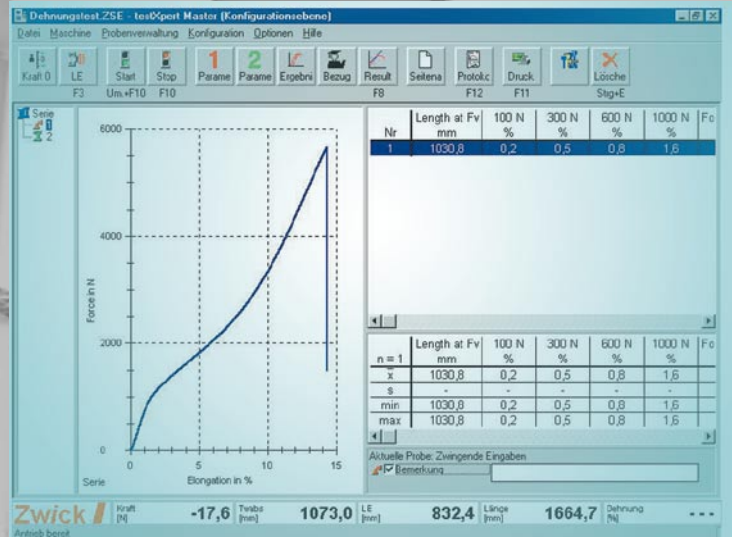
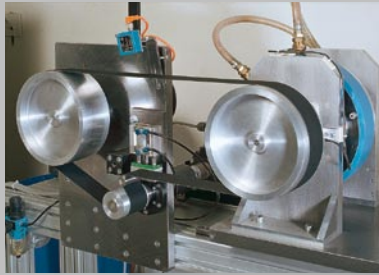

In-house, multi-purpose testing equipment enables Schlatterer to ensure precise quality inspection and assurance. We test all Esband belts and bands according to our own strict testing standards for the following properties:

1. Product length

Examination of the elongation characteristics at LO (manufacturing length) and L1 (installed length), as well as at defined tractive forces both in the production line and in the laboratory on Universal testing machines.

2. Product thickness

Inspection by means of high-quality micrometer instruments for production and by inductive sensors with pneumatically applied force for quality assurance.

3. Dynamic testing of running properties

Computer-controlled dynamic belt test rig with optical sensors for automatic measuring of width, lateral movement and centric running accuracy.

4. Static measuring of coefficient of friction

Determination of the coefficient of friction of drive belt or conveyor belt to any material chosen.



To
 Max Schlatterer GmbH & Co. KG
 D-89542 Herbrechtingen
 Federal Republic of Germany
 Fax: (0049) 7324 - 15 - 280

Please contact me. You can reach me at the following address:

YES I would like details on how your belts and bands can optimize my products!

These are my main basic data:

Type of machine:

Does the no of axles differ from 2?
 Yes No

If yes:
 Give number of axles:

Power P: kW
 or
 Torque M1: Nm

Dia. of driving pulley d_1 : mm

Maximum permissible pulley width bs_1 : mm

Rotary speed n_1 : rpm

Shaft centre distance e: mm
 adjustable by mm

Dia. driven pulley d_2 : mm

Maximum permissible pulley width bs_2 : mm

New design
 or
 Existing drive
 Number of belts

Belt dimensions (LxWxT):

Pre-tension achieved by:

Proportional shortening of the belt length with fixed shaft centres

Take up

Motor-driven rocker dolly switch

Tensioning pulley

External influencing factors:

Oil Dust Water

Chemicals

Heat °C

Does the belt operate outdoors?

Yes No

Name _____

Company _____

Street _____

Postal code/City _____

State _____

Phone number _____

Fax number _____

Other details _____

In the case of existing drives:

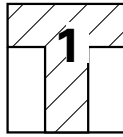
Pulley design:  1

Driving: form #:







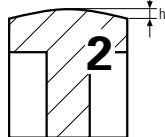



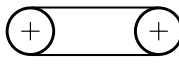

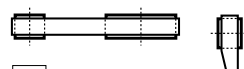
driven: form #:

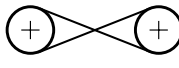
Crown height h:mm

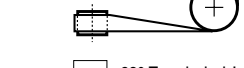
Pulley width bs :mm

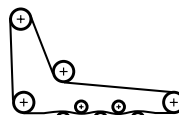
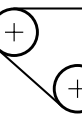
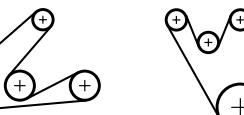
 2

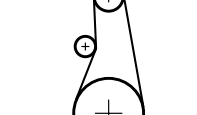
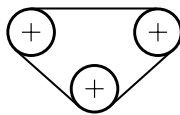
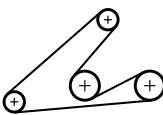
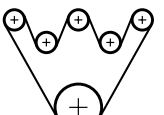
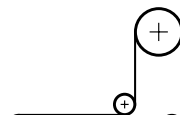
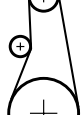
Arrangement of Belt Drive – please mark 'x' as appropriate:

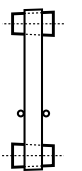
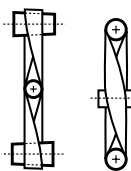
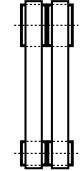
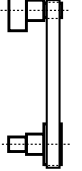
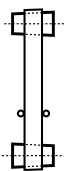
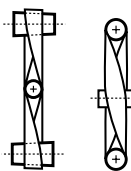
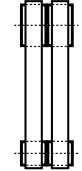
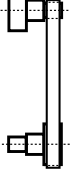
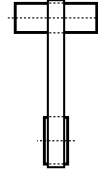
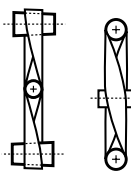
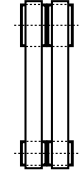
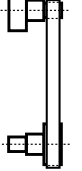
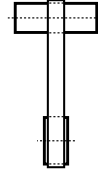
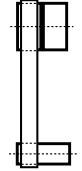
 <input type="checkbox"/> Open drive	 <input type="checkbox"/> a) horizontal	 <input type="checkbox"/> vertical shafts	 <input type="checkbox"/> 90° Turn belt drive	 <input type="checkbox"/> left <input type="checkbox"/> right
 <input type="checkbox"/> Cross belt drive	 <input type="checkbox"/> b) inclined	 <input type="checkbox"/> 90° Turn belt drive	 <input type="checkbox"/> left <input type="checkbox"/> right	 <input type="checkbox"/> Jockey drive
 <input type="checkbox"/> Four-spindle drive	 <input type="checkbox"/> c) vertical	 <input type="checkbox"/> 90° Turn belt drive	 <input type="checkbox"/> left <input type="checkbox"/> right	 <input type="checkbox"/> Tensioning roller inside
 <input type="checkbox"/> Triangular drive	 <input type="checkbox"/> Reverse drive	 <input type="checkbox"/> Multi shaft drive	 <input type="checkbox"/> Deflecting drive	 <input type="checkbox"/> Tensioning roller outside
 <input type="checkbox"/> Half-cross belt with guide roller	 <input type="checkbox"/> Conical drive a) with guide rollers	 <input type="checkbox"/> Conical cross belt drive b) with guide fork	 <input type="checkbox"/> Twin drive	 <input type="checkbox"/> Stepped pulley
 <input type="checkbox"/> Conical drive a) with guide rollers	 <input type="checkbox"/> Conical cross belt drive b) with guide fork	 <input type="checkbox"/> Twin drive	 <input type="checkbox"/> Stepped pulley	 <input type="checkbox"/> Oscillating shaft
 <input type="checkbox"/> Conical cross belt drive b) with guide fork	 <input type="checkbox"/> Twin drive	 <input type="checkbox"/> Stepped pulley	 <input type="checkbox"/> Oscillating shaft	 <input type="checkbox"/> Fixed and loose pulley

Please contact me. You can reach me at the following address:

Name

Company

Street

Postal code / city

State

Phone no.

Fax no.

Other details

Yes

I would like details on how your bands can optimize my products!

These are my main basic data:

Type of machine:

.....

Dimensions

Band length: mm

Band width: mm

Band thickness: mm

or

Dia. of driving pulley d_1 : mm

Dia. of driven pulley d_2 : mm

Shaft centre distance e: mm

Motor power: KW

Rotary speed n_1 : rpm

Number:

Goods to be transported and weight:

.....

- Belt guidance
- BGA/FDA approved
- Resistance to temperature
- Resistance to chemicals
- Antistatic
- Tensioning device or Fixed shaft centres
- Durable in extreme climate
- Weighing belt
- Slider beds

Coefficient of friction of running side:

low high

Coefficient of friction on conveying side:

low high

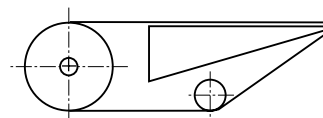

Running over Knife IBE

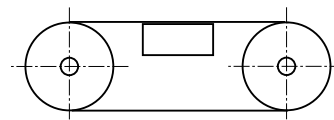

Running over rollers

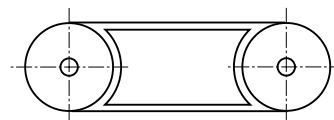

Vacuum belt
(perforations as shown in sketch)

Sketch:

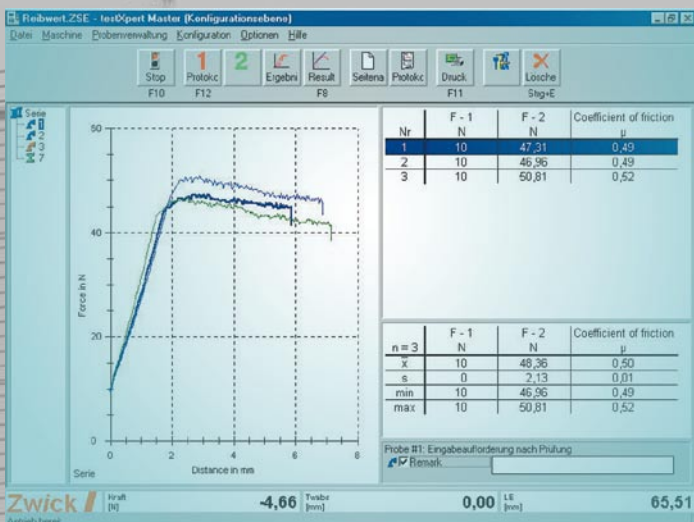

5. Breaking strength and elongation at breaking point

Determination of breaking strength (tensile force) and elongation at breaking point of flat belts and conveyor belts on Universal testing machines.

Comparison of the individual values of different belt types.

6. Endurance test / Frequent bending alterations

Determination of bending alteration ratio, i.e. influences on breaking strength, coefficient of friction, length, elongation and on the coating of the belt and conveyor belt in long-term tests.

7. Rheostat of flat belts

Determining the resistance to electric flow R_D of belts and the electrical surface resistance R_0 based on German Industrial Standard DIN 53482.

8. Abrasion of coating materials for flat belts

Comparison of the abrasion (abrasive behaviour) of coating materials for flat belts and conveyor belts against abrasion-induced wear (based on German Industrial Standard DIN 53516).

9. Testing of hardness of Shore A and Shore D

Determining the hardness of test pieces made of elastomers and rubbers based on German Industrial Standard DIN 53505.

10. Special tests

According to our customers' requirements, we conduct additional tests on product properties. In order to be able to do this, we are constantly developing new testing procedures.



MSC-130.04-E-06.08



Schlatterer
Esband

Max Schlatterer
GmbH & Co. KG
Alt-Ulmer-Straße
D-89542 Herbrechtingen
Fed. Republic of Germany
Tel.: +49(0) 73 24/15-0
Fax: +49(0) 73 24/15-280
eMail: info@esband.de
www.esband.de